

*Empower the Bar Code*



# User's Manual

PA-60 Mobile Computer

DOC NO. UM-PA605-01

Feb. 2013

Version 1.0

---

**NOTICE:** This user's manual may be revised or withdrawn at any time without prior notice.

**Copyright 2012, Argox Information Co., Ltd.  
All rights reserved.**

This manual may not, in whole or in part, be copied, photocopied, reproduced, translated or converted to any electronic or machine readable form without the prior written consent of Argox.

**Limited warranty and disclaimers**

By opening the package of this product you agree to become bound by the liability and warranty conditions as described below.

Under all circumstances this manual should be read attentively before installing and or using the product. In no event, will Argox be liable for any direct, indirect, consequential or incidental damages arising out of use or inability to use both the hardware and software, even if Argox has been informed about the possibility of such damages.

A serial number appears on all Argox products. This official registration number is strictly related to the device purchased. Make sure that the serial number appearing on your Argox device has not been removed. Servicing by our service department can only be carried out under warranty.

All Argox products are warranted for the legal warranty period after purchase, covering defects in material and workmanship. Argox will repair or, at its opinion, replace products that prove to be defective in material or workmanship under proper use during the warranty period.

Argox will not be liable in case modifications are made by the customer. In such case the standard repair charge will be applicable. The standard charge for repair will also be applicable in case no defect is found at all. These rules also apply for products that are still under warranty. Therefore, you are advised to have the product specifications always at hand.

Trademarks used are property of their respective owners.

**FCC Compliance Statement**

This device complies with Part 15 of the FCC Rules.

Operation is subject to the following two conditions:

- (1) This device may not cause harmful interface, and
- (2) This device must accept any interface received, including interface that may cause undesirable operation.

**NOTE:** This equipment has been tested and found to comply with the limits for a Class A digital device, pursuant to Part 15 of the FCC Rules. These limits are designed to provide reasonable protection against harmful interface when the equipment is operated in a commercial environment. This equipment generates, uses, and can radiate radio frequency energy and, if not installed and used in accordance with the instruction manual, may cause harmful interference to radio communications. Operation of this equipment in a residential area is likely to cause harmful interference in which case the user will be required to correct the interference at his own expense.

**FCC WARNING:** Changes or modifications not expressly approved by the party responsible for compliance could void the user's authority to operate the equipment.

---

## Table of Contents

<b>1</b>	<b>INTRODUCTION.....</b>	<b>1</b>
1.1	ABOUT THIS MANUAL .....	1
1.2	USER AND PRODUCT SAFETY .....	2
1.3	SPECIFICATIONS .....	4
<b>2</b>	<b>GETTING STARTED .....</b>	<b>6</b>
2.1	CHECK THE PACKAGE .....	6
2.1.1	PDT Package .....	6
2.1.2	Cradle Package.....	7
2.2	DETAILED VIEW .....	8
2.2.1	PA-60 Mobile Computer .....	8
2.2.2	Cradle.....	9
2.3	ASSEMBLY .....	10
2.3.1	Terminal.....	10
2.3.2	Cradle.....	11
2.4	INSTALLING, REPLACING AND CHARGING BATTERIES .....	12
2.4.1	Installing / Replacing the Battery Pack.....	13
2.4.2	Charging the Battery Pack with Cradle.....	15
2.5	INSTALLING IN A SYSTEM .....	16
2.5.1	Via CRD-22 Cradle.....	16
<b>3</b>	<b>OPERATION OF THE MOBILE COMPUTER.....</b>	<b>17</b>
3.1	KEYPAD DESCRIPTION .....	17
3.2	INSTALLING SD CARD .....	19
3.2.1	Inserting SD card into the PA-60.....	19
3.3	CONFIGURING PA-60 SETTINGS .....	20
3.3.1	Calibrating Touch Screen Alignment.....	20
3.3.2	Adjusting LCD Backlight Brightness .....	21
3.3.3	Adjusting Sound Volume .....	21
3.3.4	Using the Stylus.....	21
3.4	ENTERING INFORMATION .....	22
3.4.1	Entering Information Using a Keypad .....	22
3.4.2	Entering Information Using the Keyboard Input Panel .....	22
3.4.3	Entering Data via the Bar Code Scanner.....	22
3.5	POWER MANAGEMENT .....	23
3.5.1	Power Status Indication .....	23
3.5.2	Saving Battery Power.....	25
3.5.3	Suspend Mode .....	26
3.5.4	Resume .....	27
3.6	RESETTING THE PA-60 .....	28
3.6.1	Performing a Warm Boot .....	28
3.6.2	Performing a Cold Boot.....	28
3.7	FLASH DISK .....	29
3.7.1	Flash Disk Location.....	29
3.7.2	Saving to Flash.....	29
3.7.3	Flash Disk Size.....	30
3.8	BLUETOOTH ENABLE SETTING.....	31
3.9	WLAN CONFIGURATION STEP .....	39
<b>4</b>	<b>SCANNING .....</b>	<b>40</b>

4.1	SCAN CONFIGURATION .....	40
4.2	SCAN DRIVER .....	42
4.3	SCAN TEST .....	43
4.4	READING BARCODE .....	44
4.5	BARCODE READING PROBLEMS .....	45
5	UTILITIES .....	46
5.1	FUNCTION KEY SETTING .....	46
<b>AP SETTINGS TAB .....</b>		<b>46</b>
5.2	TIMEOUT & BRIGHTNESS .....	47
6	SOFTWARE APPLICATIONS.....	48
6.1	INTERNET EXPLORER.....	48
6.2	MEDIA PLAYER .....	49
6.3	MICROSOFT WORDPAD .....	49
6.4	REMOTE DESKTOP CONNECTION.....	49
6.5	TRANSCRIBER.....	50
6.6	WINDOWS EXPLORER .....	50
7	COMMUNICATION.....	51
7.1	ACTIVESYNC .....	51
7.2	INSTALLING MICROSOFT ACTIVESYNC .....	51
7.3	CONNECTING THE PA-60 TO ACTIVESYNC .....	52
7.4	SETTING UP A PARTNERSHIP .....	53
7.5	CONNECTING THE PA-60 .....	54
7.5.1	<i>Synchronizing Data</i> .....	54
7.5.2	<i>Solving Problems during Synchronization</i> .....	54
7.5.3	<i>Searching PA-60 Contents from a Desktop PC</i> .....	55
8	OVERVIEW OF MICROSOFT WINDOWS CE 5.0.....	56
8.1	MAIN WINDOWS .....	56
8.2	TASKBAR.....	58
8.3	SETTING UP THE PA-60 .....	60
8.3.1	<i>Certificates</i> .....	61
8.3.2	<i>Date/Time</i> .....	62
8.3.3	<i>Dialing</i> .....	63
8.3.4	<i>Display</i> .....	64
8.3.5	<i>Hot Function Key</i> .....	65
8.3.6	<i>Input Panel</i> .....	65
8.3.7	<i>Internet Options</i> .....	66
8.3.8	<i>Keyboard</i> .....	67
8.3.9	<i>Mouse</i> .....	68
8.3.10	<i>Network and Dial-up Connection</i> .....	68
8.3.11	<i>Owner</i> .....	69
8.3.12	<i>Password</i> .....	70
8.3.13	<i>PC Connection</i> .....	71
8.3.14	<i>Power</i> .....	71
8.3.15	<i>Regional Settings</i> .....	72
8.3.16	<i>Remove Programs</i> .....	73
8.3.17	<i>Scan Configuration</i> .....	74
8.3.18	<i>Storage Manager</i> .....	74
8.3.19	<i>Stylus</i> .....	75
8.3.20	<i>System</i> .....	76
8.3.21	<i>Terminal Server Client Licenses</i> .....	76

---

8.3.22	<i>Timeout and Brightness</i> .....	77
8.3.24	<i>Volume and Sound</i> .....	77
<b>9</b>	<b>TROUBLE SHOOTING</b> .....	<b>79</b>
<b>9.1</b>	<b>GENERAL CHECKS</b> .....	<b>79</b>
<b>9.2</b>	<b>READ OPERATION PROBLEMS</b> .....	<b>79</b>
<b>9.3</b>	<b>MOBILE COMPUTER PROBLEMS</b> .....	<b>79</b>

---

# 1 Introduction

Congratulations on purchasing the PA-60, a Microsoft Windows® CE 5.0 Mobile Computer. Its special combination of features makes it perfect for use in a wide range of applications. These features as:

- Microsoft Windows CE 5.0 operating system
- Robust expansion capability
- Wireless mobility via Bluetooth and 802.11b/g/n
- Long battery life
- Transmissive type color LCD display
- Backlit keypad

## 1.1 About this Manual

The chapters contained in this manual are:

Chapter 1: Introduction – Presents general information about the PA-60

Chapter 2: Getting started – Describes basic use of the PA-60

Chapter 3: Operating the Mobile computer – Describes customizing the PA-60

Chapter 4: Scanning

Chapter 5: Useful Utilities

Chapter 6: Software Applications

Chapter 7: Communication – Describes using the PA-60 for different types of communication

Chapter 8: Overview of Microsoft Windows CE 5.0

Chapter 9: Troubleshooting

Chapter 10: Appendix

---

## 1.2 User and Product Safety

- Never use strong pressure on the screen or subject it to severe impact, as the LCD panel can crack and possibly cause personal injury. If the LCD panel is broken, never touch the liquid inside, for such contact can irritate the skin.
- Although the PA-60 mobile computer meets IP54 standards for water and dust resistance, avoid prolonged exposure to rain or other concentrated moisture. Conditions exceeding IP54 standards could result in water or other contaminants entering the PA-60.
- Use only the approved AC Adapter with the PA-60. Use of an unapproved AC Adapter could result in electrical problems, or even cause a fire or an electrical shock to the user.
- Be sure that only authorized suppliers are allowed to disassemble and reassemble the device. If the device or parts are damaged due to wrong handling, the product and parts warranty is void.
- Always make back-up copies of all important data. This is easily done using a cable or single cradle (optional) to transfer data to the computer. The manufacturer is not liable for any data damage or data loss caused by deletion or corruption while using this device, or due to a drained battery.
- Lithium-ion battery packs may get hot, explode, ignite and/or cause serious injury if abused. Please follow the safety warnings listed below.

- 
- Warnings:**
- ◆ **Do not** place the battery pack in fire or heat the battery.
  - ◆ **Do not** install the battery pack backwards so the polarity is reversed.
  - ◆ **Do not** carry or store battery pack together with metal objects.
  - ◆ **Do not** pierce the battery pack with nails, strike the battery pack with a hammer, step on the battery pack or otherwise subject it to strong impacts or shocks.
  - ◆ **Do not** solder directly onto the battery pack.
  - ◆ **Do not** expose battery pack to liquid, or allow the battery contacts to get wet.
  - ◆ **Do not** disassemble or modify the battery pack. The battery pack contains safety and protection devices, which, if damaged, may cause the battery pack to generate heat, explode or ignite.
  - ◆ **Do not** discharge the battery pack using any device except for the specified device. When it is used in devices other than the specified devices, the battery pack can be damaged or its life expectancy reduced. If the device causes any abnormal current to flow, it may cause the battery pack to become hot, explode or ignite and cause serious injury.
  - ◆ In the event the battery pack leaks and fluid gets into the eyes, do not rub the eyes. Rinse well with water and immediately seek medical care. If left untreated, the battery fluid could cause eye damage.
-

---

To avoid malfunctions and to ensure years of trouble-free operation, pay attention to the following:

### General Use

---



**Do not** expose the mobile computer to areas subject to extreme heat such as direct sunlight, near a heater, or in a car – or in areas that are very cold, humid, moist, or dusty.



**Do not** expose the product to rain or water.



**Do not** subject the product to strong impact, or throw or drop the mobile computer from large heights. Do not allow other mechanical shocks to the product.

---

### Cleaning Instructions

---



Clean the exterior by wiping it with a soft, dry cloth. **Do not** use much water.



**Do not** use thinner, white spirit or other solvents. These can discolor the case and the keys and it has a negative effect on the lifetime of the keys.

---

### Cleaning the Mobile Computer

---

Clean the scan window periodically for better reading performance, but pay attention to not scratching the window

---

### Cleaning the Cradle

---

Avoid touching the contacts in the cradle. The contacts must stay as clean as possible to maintain optimal charging capacity. **Do not** use water when cleaning the cradle. This can cause malfunction of the chargers.

---

### Using the Mobile Computer

---



Avoid temperature changes. Sudden temperature changes can cause condensation to form on the mobile computer. Using the mobile computer while condensation is present can cause malfunction. Always wait until the condensation clears naturally before attempting operation.



**Do not** leave the mobile computer in an area where static charge is accumulated or near devices where electromagnetic emission is generated.

**Do not** place any object on top of the mobile computer. **Do not** lay the mobile computer face down. Doing so can cause accidental operation of the power key or [ENT] key, which can discharge your batteries or change settings you **do not** want changed.

---

### Using the Cradle

---

**Do not** place any product other than the PA-60 mobile computer in the cradle.

---

### Maintenance

---



There are no user-serviceable parts inside the mobile computer or the cradle. So **do not** try to take it apart. The manufacturer will not be liable for any damage caused by customers. In case of a malfunction that can not be solved by the troubleshooting instructions in this manual, please consult our service department.

---



---

---

## 1.3 Specifications

<b>Model</b>	<b>PA-6030</b>
<b><i>Wireless Communication</i></b>	
WPAN	Bluetooth Class2, version 1.2
WLAN	Wi-Fi 802.11b/g/n
<b><i>External I/O interface</i></b>	
	USB / RS-232(4 Wires)
<b><i>Expansion slot</i></b>	
	Standard SD
<b><i>General Characteristics</i></b>	
OS	Windows CE 5.0
CPU	ARM9 Core 533MHz
RAM	256MB DRAM
ROM	256MB Flash
Display	2.4" LCD TFT Transmissive, 240 x 320 QVGA 65K colors with Touch panel
LED	Blue, Green and Red
Keypad	29 Numeric
Alert	Speaker, Vibrator
<b><i>Power</i></b>	
Operating power	1) Mobile Computer: Rechargeable 3.7V 1950mAh Li-Polymer Battery 2) Optional Pistol Grip: Rechargeable 3.7V 5000mAh Li-ion Battery
Working hours	> 8 hours
Backup power	15-min data retention
Data retention	30 days

\* Batteries must be charged at a temperature ranging from 0~+45°C (+32°F to +113°F). At temperatures below 0°C and above +45°C display or battery performance degradation may occur.

---

---

**Developing tools**

Visual Studio 2005, Visual Studio 2008 , Windows CE SDK

---

**Scanner Configuration Utility**

---

**Scanner**

Scanner system Long Range CCD scanner 2048 pixels

Resolution 0.127mm (5mil) at PCS 90%

Depth of field 600mm (code 39, 20mils, PCS 90%)

Scanning rate 400 scans /sec

Readable barcode Supported all popular linear barcodes included GS1 databar, Code 39, Code 93, Codabar, Code 128, UPC A, UPC E, Interleaved 2/5, Matrix 2/5, MSI, Standard 2/5, Code 39 Full ASCII, EAN/UPC ext;

---

**Environment**

Operating Temperature -10°C to 60°C / 14°F to 140°F

Storage Temperature -20°C to 70°C / -4°F to 158°F

Humidity 1) Operating: Non-condensed 10-90%  
2) Storage: Non-condensed 5-95%Impact resistance 1) 1.2M/4ft (Terminal) 0.9M (Cradle)/(4 drops per 6 sides)  
2) IP54Electrostatic discharge 1) +/- 15 KV air discharge  
2) +/- 8 KV direct discharge

EMC Regulation FCC, CE

---

**Accessory**Charging & Communication Cradle / Pistol Grip /  
Charging cable / Four slot charging cradle/ Holster

---

## 2 Getting Started

This chapter describes the PA-60 physical characteristics, how to install and charge the batteries, how to remove and replace the strap assembly and how to start the PA-60 for the first time.

### 2.1 Check the package

Carefully remove all protective material from around the PA-60 and save the shipping container for later storage and shipping.

Depending on the configuration ordered, the PA-60 shipping container may include:

#### 2.1.1 *PDT Package*

- v PA-60
- v Battery pack
- v Hand strap
- v Power supply
- v Power plug
- v Quick Reference Guide
- v CD ROM
- v Stylus
- v Thread

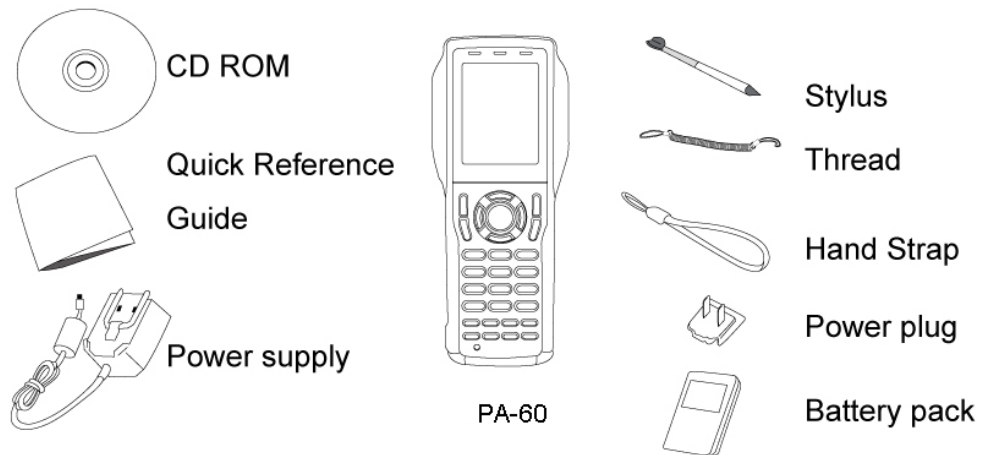
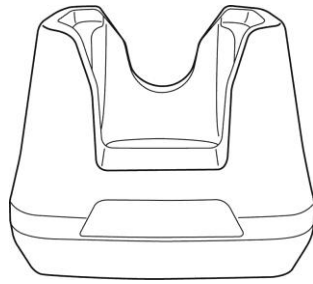

Figure 2-1 Compact Package

---

## 2.1.2 Cradle Package

v CRD-22



Cradle

v USB cable

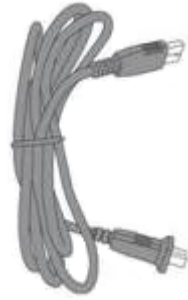

USB cable

Figure 2-2 Cradle Package

Inspect the package contents for damage. If any item is missing or damaged, please contact the Argox Technical Support Center immediately.

---

## 2.2 Detailed View

The pictures below provide information on the PA-60's various buttons, ports and other functions.

### 2.2.1 *PA-60 Mobile Computer*

#### Dimensions of the PA-60

168.8mm (L) x 70.1 mm (W) x 34.0mm (H)

#### Details of the PA-60

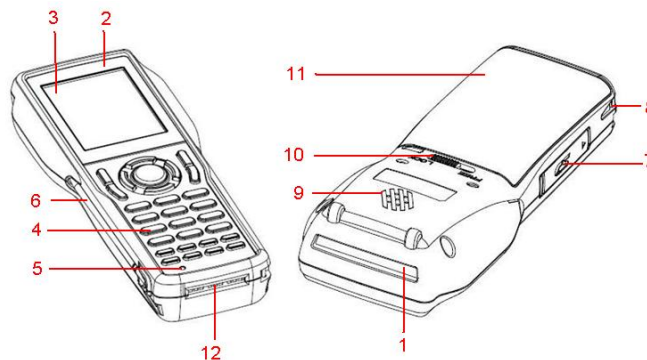

Figure 2-3 The details of Terminal

1	Reading Window	Optical beam of LED for barcode reading will be emitted from here
2	LED Indicator	Can be used to indicate results, for example bar code reading / status of communication
3	Touch Screen	Use the stylus to perform specific actions on the touch panel.
4	Stroke keys	A total of 29 keys are provided to turn power ON and OFF and for other operations.
5	Reset switch	Use a paper clip or other thin object to press the RESET switch located inside the hole.
6	Stylus	
7	SD card slot	
8	Hand strap hook	Used to install the hand strap
9	Speaker	
10	Main battery compartment lock	Locks the main battery compartment cover in place. Terminal power is automatically cut if the cover is removed.
11	Main battery compartment	Holds main batteries
12	Power Contacts	The terminal is used to supply power from Cradle.

---

## 2.2.2 *Cradle*

### Dimensions of the CRD-22 Cradle

162.4mm (L) x 112mm (W) x 93.9mm (H)

### Details of the CRD-22 Cradle

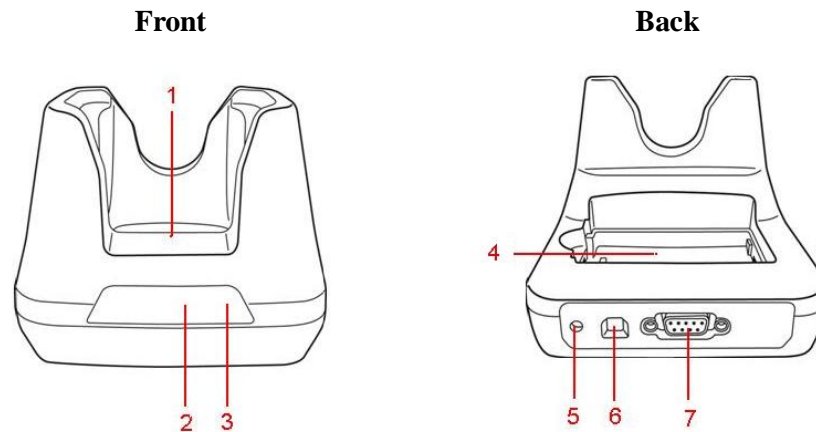

Figure 2-4 The Details of Cradle

1	Terminal Slot	Put the terminal on the cradle through this slot for data transmission or charging
2	Power LED Indicator	Power indicates
3	Charging LED Indicator	Indicates the charge status of the battery. Green: no battery or charging complete Red: battery is charging
4	Charging Slot	For charging a spare rechargeable battery pack
5	DC Input Socket	Input for AC adapter
6	USB Socket	For connecting to PC USB port through a standard USB cable
7	RS-232 Socket	For connecting to PC serial port through Argox RS232 cable

---

## 2.3 Assembly

Follow the next steps to make your terminal ready for installation in a system that is described further in the manual.

### 2.3.1 *Terminal*

The hand strap protects the Terminal from being damaged as a result of it being dropped by mistake during movement. Follow the procedure below to attach the hand strap.

#### To attach the hand strap

1. Fix the small cord of the strap around the pillar of the terminal.
2. Insert the handle of the strap in the thin loop.
3. The strap is fixed to the terminal.
4. Hold the hand strap around the wrist when carrying the terminal.

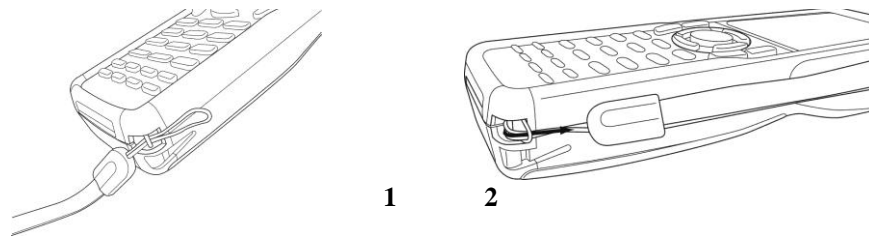

Figure 2-5 Hand Strap

---

Important: **Do not** swing the terminal around

---

#### Start with a full battery

1. To be sure of proper operation, it is advised to start with a full battery, charge the battery pack according to the instructions in the next chapter.
2. Click the battery pack into the terminal as instructed in the next chapter.

---

### 2.3.2 *Cradle*

#### **Power Connection**

1. Attach the DC jack of the AC adapter into the socket of the cradle. Then connect the AC adapter to the mains outlet. Both LED on the cradle turns green.

#### **Battery charging**

1. When the spare battery put in the charging slot, the charging LED on the cradle turns red during charging state and gets green when fully charged.
2. When the PA-60 terminal with the rechargeable battery placed in the cradle to charge, the charging LED on the Terminal turns on in red and gets green when full charged.

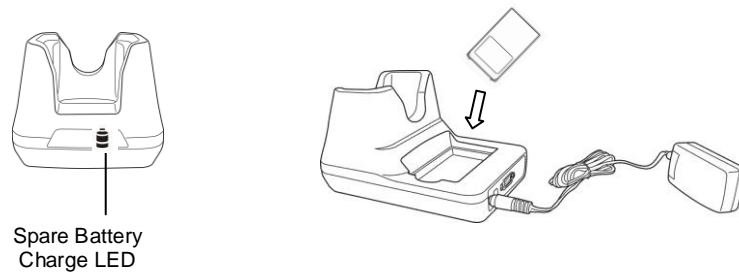

Figure 2-6 BatterCharging

#### **Terminal on cradle**

Take notice that the PA-60 cradle is designed for the PA-60 or PA-20 terminal. No other type of terminal can be placed into this cradle. This can cause damages to the connector on the cradle.

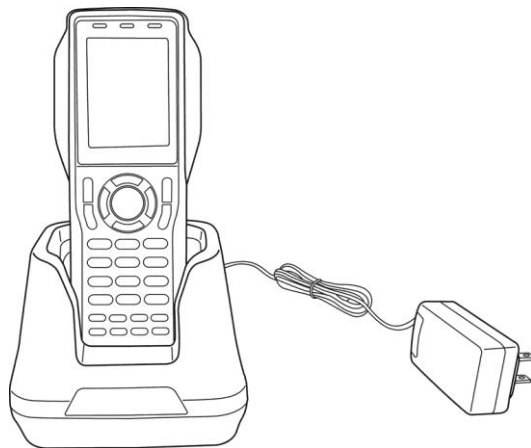

Figure 2-7 Charging



---

## 2.4 Installing, Replacing and Charging Batteries

Wrong use of batteries might cause serious damage to the terminal or to the cradle. In order to avoid damage, it is very important to take notice of the instructions.

- 
- Caution:**
- ◆ **Insert a fully-charged battery pack before use of the terminal.**
  - ◆ **Never remove the main batteries while the terminal is turned on.**  
Doing so may lose data in the terminal.
  - ◆ **Use only recommended batteries.**  
When other batteries are used, defects or other problems can occur. Before installing (new) batteries, please make sure you are using the recommended batteries.
  - ◆ **Use the right charger for batteries.**  
The rechargeable battery pack form Argox can be charged in the cradle when either it is in the terminal or alone in the charging slot in the back of the cradle.
  - ◆ **The life of a battery pack is limited, and charging a battery pack causes it to gradually lose its ability to maintain a charge. If your battery pack requires frequent charging, it probably means it is time to purchase a new one.**
  - ◆ **Strictly follow the instructions for installing, charging, and removing the batteries.**  
The products are not warranted for damage, defects, malfunction, or loss of data, resulting from incorrect use of batteries.
- 

### Required batteries:

The terminal needs both main battery and backup battery for operation.

#### Main Battery

Terminal: Rechargeable 3.7V 1950mAh Li-Polymer Battery

Gun type: Rechargeable 3.7V 4400mAh Li-Ion Battery

---

## 2.4.1 Installing / Replacing the Battery Pack

### How to install or replace the main battery in the terminal

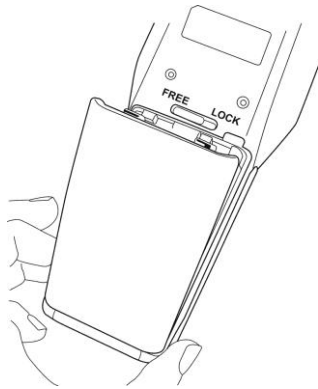

Figure 2-8-1 Installing /Replacing The Battery Pack

- 1 Slide the main battery compartment cover lock to the **FREE** position and remove the cover

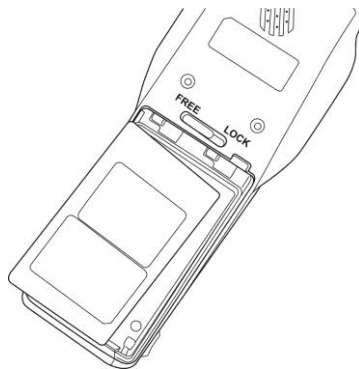

Figure 2-8-2 Installing /Replacing The Battery Pack

- 2 Load a lithium-ion battery pack into the main battery compartment in the direction shown in the figure

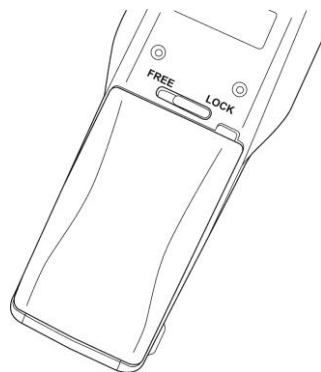

Figure 2-8-3 Installing /Replacing The Battery Pack

- 3 Attach the battery compartment cover to the terminal and slide the main battery compartment cover lock to the **LOCK** position.

---

**Note:** Please follow the above procedure in reverse to reassemble the battery cover.  
**Be sure to turn the terminal OFF before you do this.**

---

---

## How to install or replace the battery in the gun grip

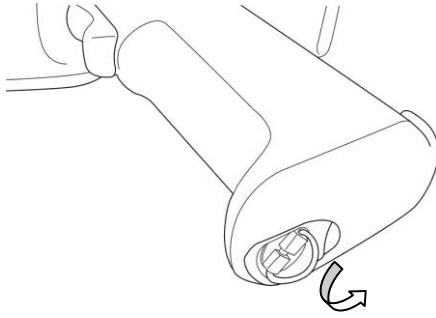

1 Turn the screw

Figure 2-9-1 Installing /Replacing The Gun Grip Battery

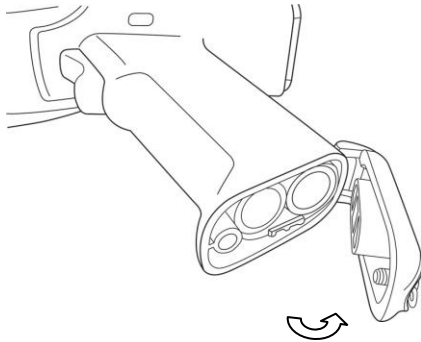

2 Open the cover

Figure 2-9-2 Installing /Replacing The Gun Grip Battery

---

## 2.4.2 Charging the Battery Pack with Cradle

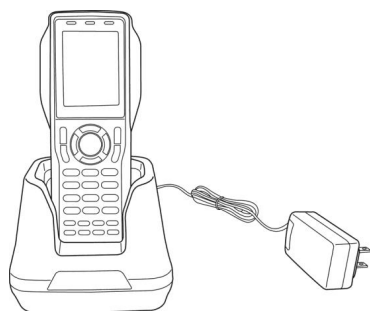

Figure 2-10 Charging with Cradle

### a) Leaving the battery pack inside the Mobile computer

1. Connect the power adaptor to a power source
2. Plug in the connector of the power adaptor to the Cradle
3. Insert the Mobile computer into the Cradle

---

**Note:** When charging the battery pack, the Power LED on the Mobile computer turns Red. After the battery pack is fully charged, the Mobile Computer Power LED turns green.

---

### b) Placing the spare battery pack into the Cradle's spare battery charging slot

1. Connect the power adaptor to a power source
2. Plug in the connector of the power adaptor with Cradle
3. Insert the battery pack into the Cradle's spare battery slot

---

**Note:** When charging the battery pack in the Cradle's spare battery slot, the Cradle charging LED is Red. After the battery pack is fully charged, the LED turns green.

---

### **Caution:** Ambient Temperature Ranges for the Battery Pack

- ◆ **Temperature ranges for battery pack use in the terminal, charging, and storage is specified below. Temperatures outside these ranges create the danger of deterioration of battery pack performance and shortening of its service life, as well as fluid leakage and heat generation.**

Operating Temperature: -20°C to 50°C

Charging Temperature 0°C to 40°C

Storage Temperature: -20°C to 60°C

- ◆ **If the battery pack charge indicator does not light during charging, remove the battery pack and then re-attach it. If this does not solve the problem, it means that the battery pack is defective and needs to be replaced.**
  - ◆ **Use only the specified battery pack.**
  - ◆ **Battery packs naturally discharge even when they are not loaded in the terminal. Use a battery pack as soon as possible after charging it.**
  - ◆ **For best charging results, keep the cradle, terminal and battery pack contacts clean by periodically wiping them off with a cotton swab or dry cloth.**
-

---

## 2.5 Installing in a System

---

**Notes:** Exercise caution at all times when working with AC-powered equipment. Turn off your devices before installation.  
Because of the special pin-out of the connectors, use the cables supplied by the manufacturer.  
Do not modify the cable provided by the manufacturer. If you need a special cable for some cases, contact your supplier to purchase the right cables or technical support.

---

### System Connection (Data Communication)

The PA series portable data mobile computers let you link to a host computer through RS-232 cable or the CRD-22 cradle for data communication.

#### 2.5.1 Via CRD-22 Cradle

The CRD-22 cradle provides two methods for data transmission: through RS-232 cable (9-pin connector for PC and 9-pin connector for mobile computer) or through USB cable.

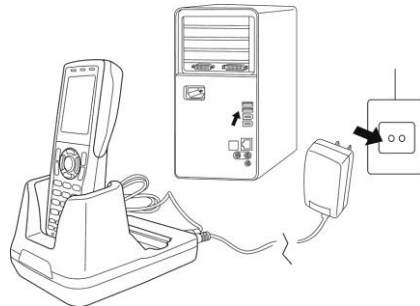

Figure 2-11 Communication through Cradle

## 3 Operation of the Mobile Computer

### 3.1 Keypad Description

The PA Series keypad consists of 29 rubber keys including one SCAN key.

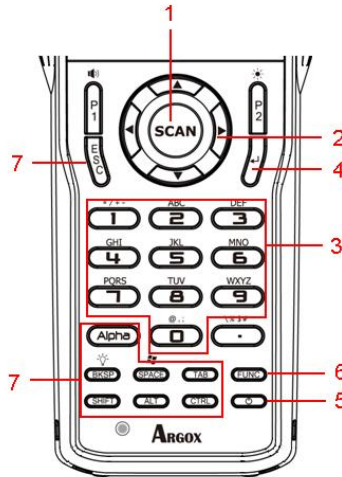

Figure 3-1 Keypad Description

#### 1. Scan key

Scan a bar code read operation

#### 2. Navigation key

This cursor key navigates among applications.

#### 3. 10-key pad

The function of these keys depends on whether the Terminal is in the character input mode or the number input mode:

Character input mode: Input alphanumeric and symbols.

Number input mode: Inputs the numbers 0 to 9 and the decimal point.

#### 4. ENT key

Enter key.

#### 5. Power key

Turns power ON and OFF.

#### 6. Function keys (Combination key)

Keys that can be assigned any function. The following are the initial functions assigned to these keys.

FUNC + (P1) Adjust speaker volume

FUNC + (P2) Adjust LCD Backlight

FUNC + (BKSP) Turns the keypad Backlight ON / OFF

FUNC + (SPACE) shortcut for Windows Start key

FUNC + (TAB) Touch Panel calibration

FUNC + (1) ~ (9) Shortcut for user define key or application

(P1) ,(P2) Shortcut for user define key or application

---

---

### ***7.Control keys***

ALPHA	Switches between the number input mode or the character input mode. When [1] on the screen Icon-Bar indicate that the input mode at number input mode. (Default on number mode) When [a] or [A] on the screen Icon-Bar indicate that the input mode at character input mode.
ESC	Escape key
BKSP	Backspaces key
SPACE	Space key
TAB	Tab key
ALT	Alt key
CTRL	Control key
SHIFT	Shift key

---

## 3.2 Installing SD card

---

**Caution:** Make sure you have fully charged the battery before turning the unit on.

---

### 3.2.1 *Inserting SD card into the PA-60*

1. Open the SD cover.
2. Insert a correctly oriented SD card.
3. Close the SD cover.

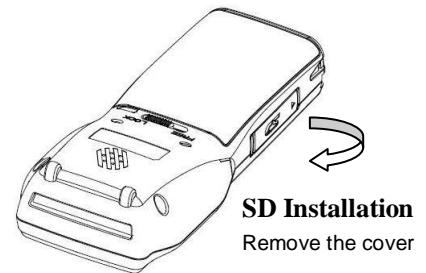

Figure 3-2 Installing SD Card

---

**Note:** When removing an SD card, please press “push” first.

---



---

## 3.3 Configuring PA-60 Settings

### 3.3.1 Calibrating Touch Screen Alignment

#### Calibrating the PA-60

This screen can be accessed at any time by pressing the hot key “FN” and “TAB” key. Or by accessing the menus and tab in order of Start → Settings → Control Panel → Stylus → Calibration.

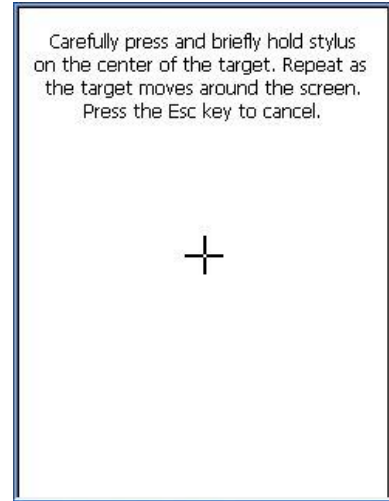

Figure 3-3 Calibration

Whenever the response of the touch screen is poor, or the operations executed do not match your tapping on the touch screen, please recalibrate the alignment of the touch screen using the following method.

- A. Press the stylus against the center of the target mark (+ mark) as indicated on the screen. The screen shown to the right appears after you press the stylus against the target at five different locations.
- B. Press the Execute key or tap anywhere on the touch screen

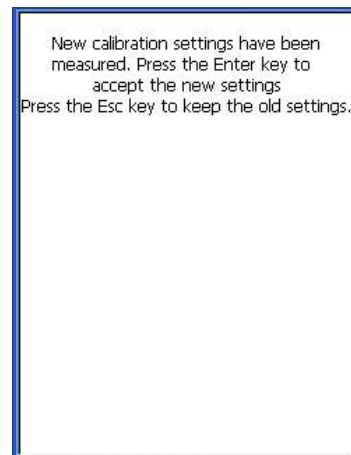

Figure 3-4 Calibration

---

### 3.3.2 Adjusting LCD Backlight Brightness

You can use the following procedures to adjust display brightness to make it easier to read under different lighting conditions.

- Press the “FN” + “P2” key and then press the “▲” or “▼” key. Press the “▲” key adjusts brightness for a lighter display, while pressing the “▼” key adjusts brightness for a darker display.
- To continue making adjustments, press the “▲” or “▼” after pressing the “FN” + “P2” key.
- Brightness settings are also made by accessing the menu and tab in order of **Start** → **Settings** → **Control Panel** → **Timeout&Brightness** → **Brightness**.

### 3.3.3 Adjusting Sound Volume

You can use the following procedures to adjust sound to make it easier to hear under different working conditions.

- Press the “FN” + “P1” key and press the “▲” or “▼” key. Press the “▲” key adjusts for a louder sound, while pressing the “▼” key adjusts for a softer sound.
- To continue making adjustments, press the “▲” or “▼” after pressing the “FN” + “P1” key.
- Sound settings are also be made by accessing the menu and tab in order of **Start** → **Settings** → **Control Panel** → **Volume & Sounds**

### 3.3.4 Using the Stylus

The stylus is located next to CF cover or hand-strap on the rear of the PA-60 as illustrated in figure 2-3 PA-60 Back view (page 8). The stylus functions the same as a mouse on a PC. Use the stylus to:

- Navigate the display, select menu items and open optional applications.
- Tap the characters on the soft keyboard panel
- Hold the stylus on the screen and drag across the screen to select a list of multiple items.

---

**Caution:** Never use a pen, pencil, or other sharp object on the display to avoid damaging the touch screen.

---

---

## 3.4 Entering Information

To enter information:

- Use the keypad
- Use the keyboard input panel (soft keyboard) to enter text.
- Scan bar code data into data fields.
- Use Microsoft ActiveSync to synchronize or copy information from the host computer to the PA-60. For more information on ActiveSync, refer to Chapter 6.

### 3.4.1 *Entering Information Using a Keypad*

The alphanumeric keypads produce the 26-character alphabet (A-Z), numbers (0-9), function keys and assorted characters. The keypads default characters/functions are printed white.

### 3.4.2 *Entering Information Using the Keyboard Input Panel*

Use the keyboard input panel (soft keyboard) to enter information in any program. To launch the keyboard input panel, press the button on the taskbar. Tap a key to enter a value. Tap a keyboard input panel button to display or hide the keyboard input panel.



Figure 3-5 Input Panel

### 3.4.3 *Entering Data via the Bar Code Scanner*

The sample bar code scanner application scans data into data fields in the same way data is entered via the keypad.

---

## 3.5 Power Management

### 3.5.1 *Power Status Indication*

Checking main and Backup Battery Status

#### Enter “Power Properties”

If the above mentioned “Plug” or “Battery” icon is displayed, double tap this icon to bring up the “Power Properties” screen.

Or, select **Settings/ Control Panel** from the **Start** menu and then double tap the “**Power**” icon to display “**Power Properties**”.



Figure 3-6 Settings/Control Panel

#### Check Battery Status:

The battery menu item shows the status of the main and backup batteries.

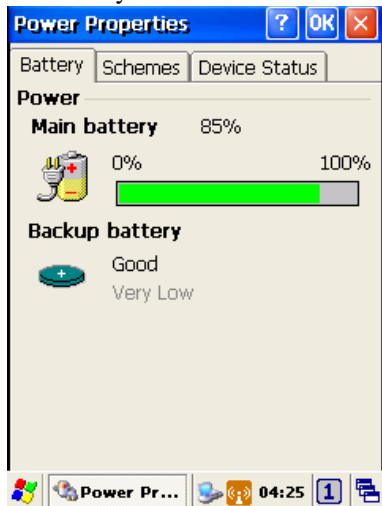





Figure 3-7 Power Properties

---

Five different icons are displayed on the status bar to indicate the on-board power status.

Icon	Description
No icon:	Indicates there is no external power supply to the PA-60 but the battery power status is good.
“Plug” icon:	 Shows external power is in use. The PA-60 is either plugged-in via the DC 5V/2.5A power adapter or in the cradle.
“Charging” icon:	 Indicates that the battery is charging.
“Battery Low” icon:	 Shows there is no external power supply, the battery charge is low.
“Battery Very low” icon:	 Indicates the battery is very low. Stop operation and charge the PA-60 immediately.

You must charge the battery when the battery “Very Low” icon is displayed. If the “Very Low” icons still show after charging, please contact Argox Technical Support.

---

### 3.5.2 *Saving Battery Power*

#### **Automatic shut-down of the PA-60**

The PA-60 enters idle mode when there is no task or if all tasks are waiting for input. In default setting, the PA-60 automatically turns itself off if idle for 3 minutes and when there is no external charging power. Press the power button to return the PA-60 to the same point at the time of automatic shutdown.

In Power Properties, select “Schemes”. Customize automatic shut off time by tapping the arrow to select from a list of time periods. The available time periods are 1, 2, 3, 4, 5, 10, 30 minutes and never.

Activate this function when the PA-60 is plugged into the power adapter or placed in its cradle by tapping the check box and then tapping the arrow to select from a list of time periods. The available time periods are 1, 2, 3, 4, 5, 10, 30 minutes and never.

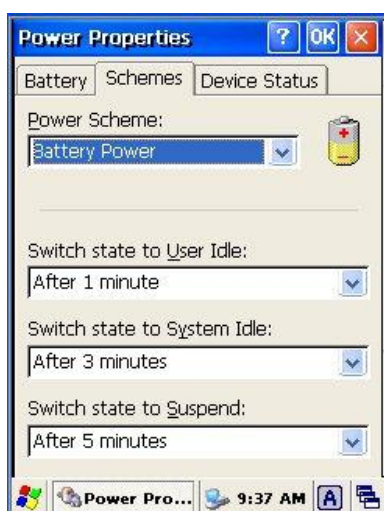

Figure 3-8 Power Properties

#### **Backlight Setting**

Because the power consumption of the LCD backlight is high, turn off the backlight function when it is not necessary. If a backlight is required, set “automatically turn off the back-light.”

To change the backlight setting, select **Settings / Control Panel** from the Start menu, and then double tap the “**Timeout & Brightness**” icon.

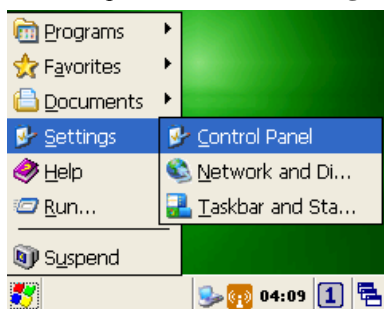

Figure 3-9 Backlight Setting

---

Tap the “Backlight” menu item to display the following 2 selections:

**Automatically turn off the backlight when using battery power:**

Tap the check box to toggle this function. Available idle times are: Off, Micro, Fine, Normal and Super.

**Automatically turn off the backlight when using external power:**

Tap the check box to toggle this function. Available idle times are: Off, Micro, Fine, Normal and Super.

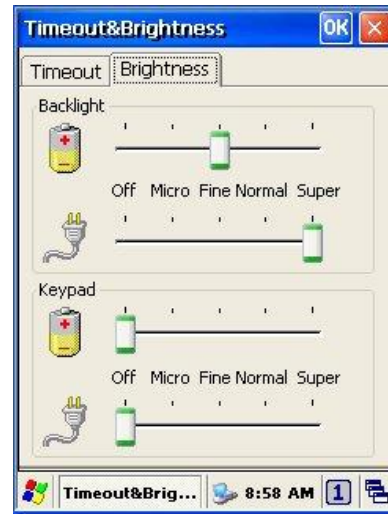



Figure 3-10 Timeout & Brightness

### 3.5.3 Suspend Mode

The PA-60 will go into suspend mode when it is idle for a period of time. Customize the idle duration using the Power control panel (refer to Figure “Schemes Tab”). Suspend mode appears just like you have turned the unit off. Press the  key to suspend the PA-60. Press the  key again for the PA-60 to resume its previous state.

Use the Battery Power control panel to set the duration to switch to Suspend mode when the system uses battery power. This saves battery power when the PA-60 is not in use.

**Entering Suspend Mode:**

The following puts the PA-60 in suspend mode:

- Press  key while the unit is on.
- The duration timer for “Switch state to Suspend” expires, which indicates that there has been no use for a specified of time.
- The battery pack discharges completely.
- Tap Start > Suspend

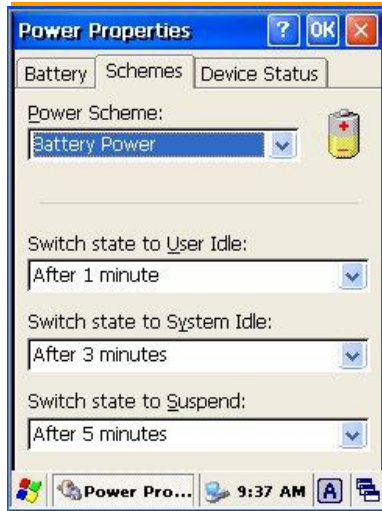

Figure 3-11-1 Suspend Mode setting



Figure 3-11-2 Suspend Mode setting



Tap here to put the PA-60 into suspend mode

### 3.5.4 *Resume*

Press  key to suspend or resume (wake up)

#### **Waking the PA-60**

The default wakeup conditions define what actions wakeup the PA-60. These settings are configurable and the factory default settings are subject to change / update.

Status	Description	Condition for Wakeup
Power Off	When the PA-60 is set to suspend mode by pressing  , this action wakes the PA-60.	Press  button
Auto Off	When the PA-60 enters suspend mode by automatic power-off, this action wakes the PA-60.	Press  button



---

## 3.6 Resetting the PA-60

If the PA-60 stops responding to input, reset it. There are two reset functions, warm boot and cold boot. A warm boot restarts the PA-60 by closing all running programs. All data that is not saved is lost.

A cold boot also restarts the PA-60, but erases all stored records and entries from RAM. In addition it returns formats, preferences and other settings to the factory default setting.

Perform a warm boot first. If the PA-60 still does not respond, perform a cold boot.

### 3.6.1 *Performing a Warm Boot*

**To perform a warm boot:**

- a. Press “Reset ”. **Do not** hold down any other keys or buttons.
- b. The PA-60 demo window appears.

---

**Caution:** Files that remain open during a warm boot may not be retained.

---

### 3.6.2 *Performing a Cold Boot*



A cold boot restarts the PA-60 and erases all user stored records and entries from RAM. Only perform a cold boot if a warm boot does not solve the problem.

---

**Caution:** Cold boot resets the PA-60 to the default settings. All added applications and all stored data are removed. **Do not** cold boot without support desk approval.

---

**To perform a cold boot:**

1. Press the “Reset ” and “Power ” keys together. **Do not** hold down any other keys or buttons. As the PA-60 initializes the Argox welcome screen appears for about a minute.
2. Calibrate the touch screen. See instructions on calibrating the PA-60 screen in chapter 3.

---

### 3.7 Flash Disk

Flash memory is a re-writable location in which to store 256MB of programs and data files. The benefit of this feature is that files and programs saved in Flash Memory are unaffected by the PA-60's power status.

---

**Note:** The Flash Disk storage memory persists for all reset (warm/cold reboot) conditions and software/firmware updates. We strongly recommend installing all applications, applets, programs, and important data files to the Flash Disk location.

---

**Caution:** If an application or a data file is installed or saved in RAM, a cold reset will result in the loss of that application or data file.

---

#### 3.7.1 *Flash Disk Location*

To access the contents of Flash Disk storage:

- Double-tap the **My Device** icon on the desktop
- Double-tap the **Flash Disk** icon to view **Flash Disk**.



Figure 3-12-1 My Device screen

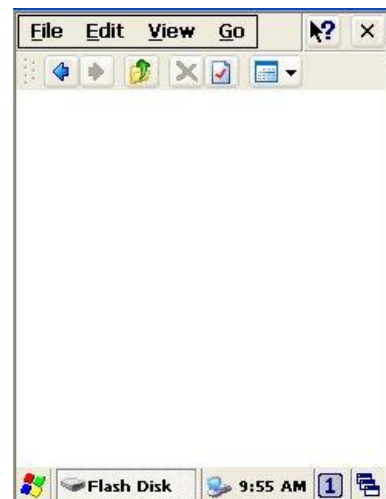

Figure 3-12-2 Flash Disk

#### 3.7.2 *Saving to Flash*

To save an application or data to Flash Memory from your current application, select File → Save As → navigate to the Flash Disk location and save it.



Figure 3-13 Save to Flash Disk

---

### 3.7.3 *Flash Disk Size*

The size of the Flash Disk varies depending on the size of the system firmware.

- A. Inside the Flash Disk directory, tap File → Properties
- B. The Flash Disk Properties dialog:

The number following Free is the amount of memory currently available on your device.

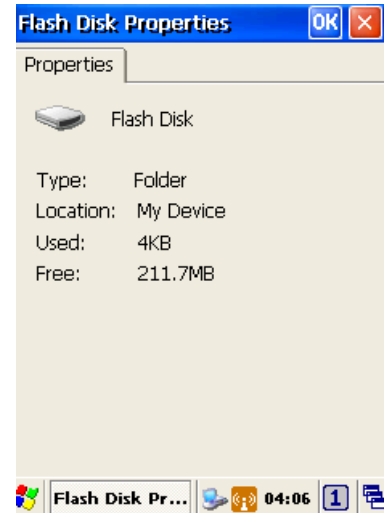

Figure 3-14 Flash Disk Properties and Size

---

### 3.8 Bluetooth Enable Setting

3.8.1 Please enable Bluetooth first like Figure 3-15.

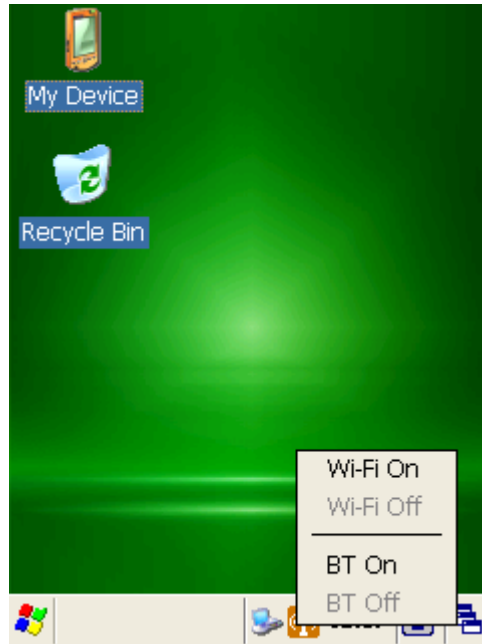

Figure 3-15 Enable Bluetooth

3.8.2 After enable Bluetooth, please double click **BT Icon** like figure 3-16

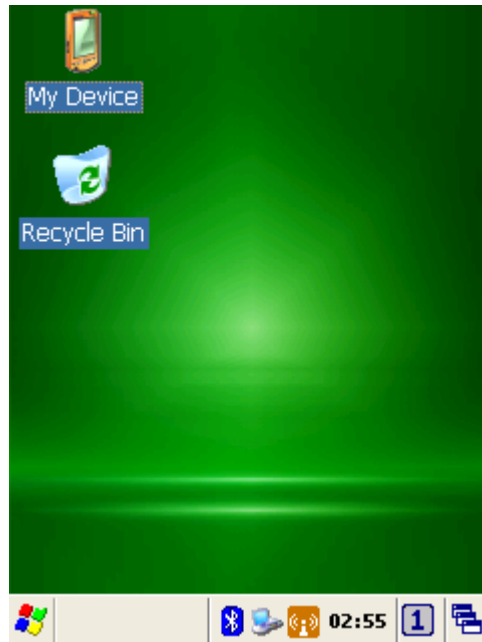

Figure 3-16-1 BT Icon

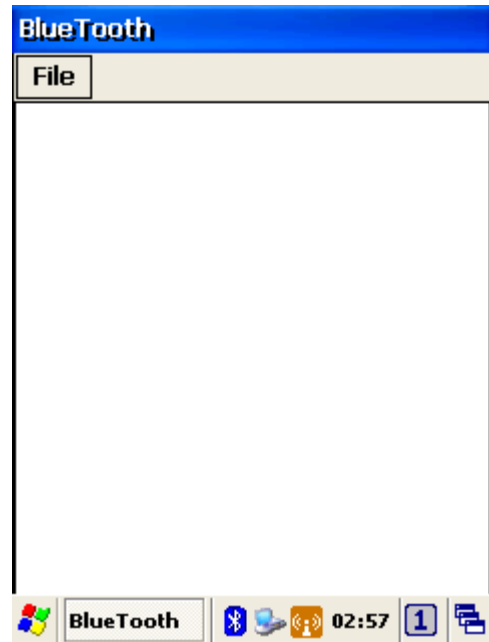

Figure 3-16-2 Show BT

3.8.3 On Bluetooth manager screen, select **file** → **new connection** like Figure 3-17.

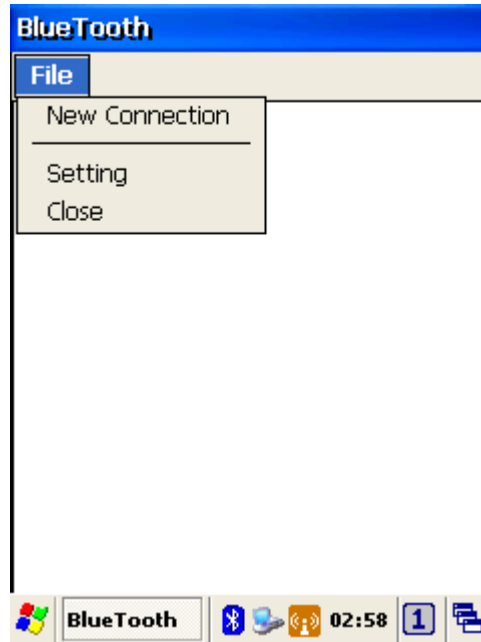

Figure 3-17 Bluetooth connection

3.8.4 Bluetooth has four functions to choose like Figure 3-18.

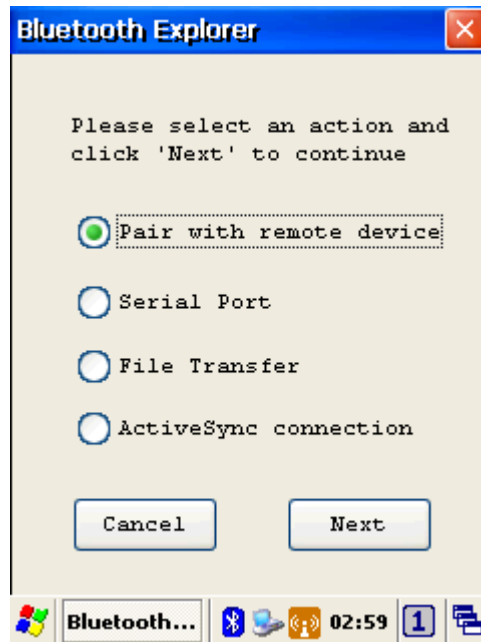
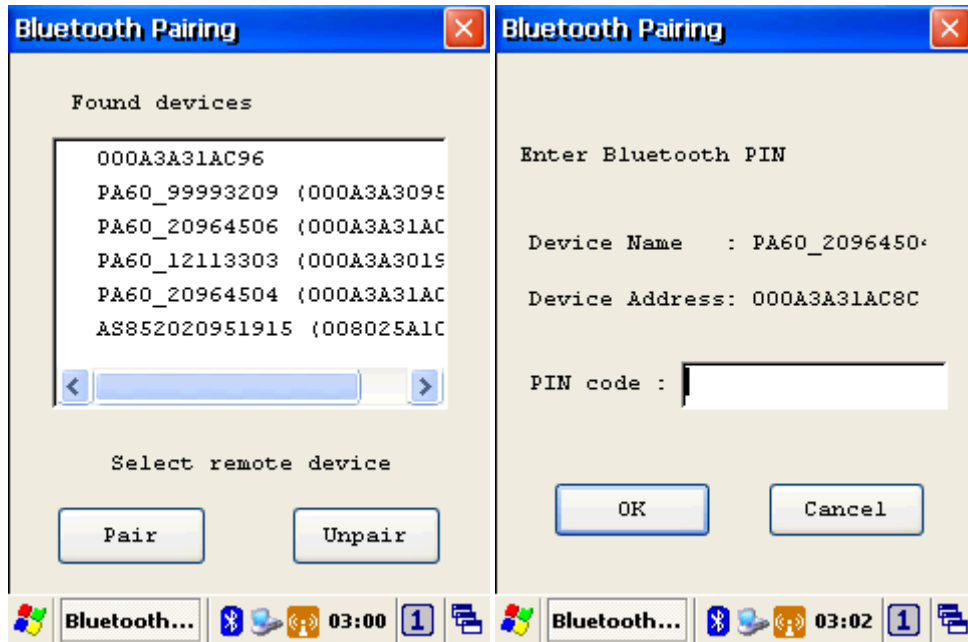

Figure 3-18 Bluetooth Explorer

3.8.5 First function is Pair with remote device, after press next button.

It will start to search devices. Select a device and press Pair button; it needs to enter Bluetooth PIN code like Figure 3-19.



3.8.6 After PA-60 check pin code with device. PA-60 will appear a pop window and show success message like Figure 3-20.

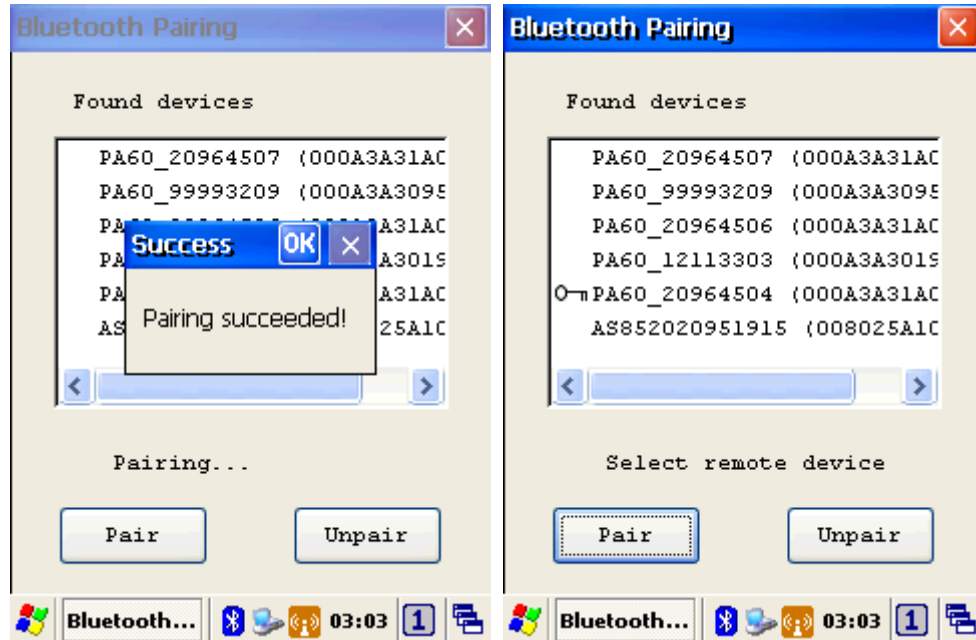

3.8.7 Second function is serial Port which communication with device via com port like

Figure 3-20.

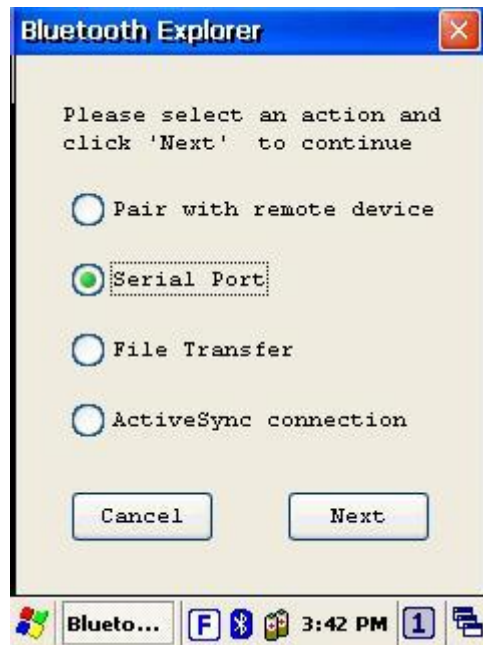

Figure 3-20

3.8.8 After press **next** button, it will start to search device like Figure3-21.

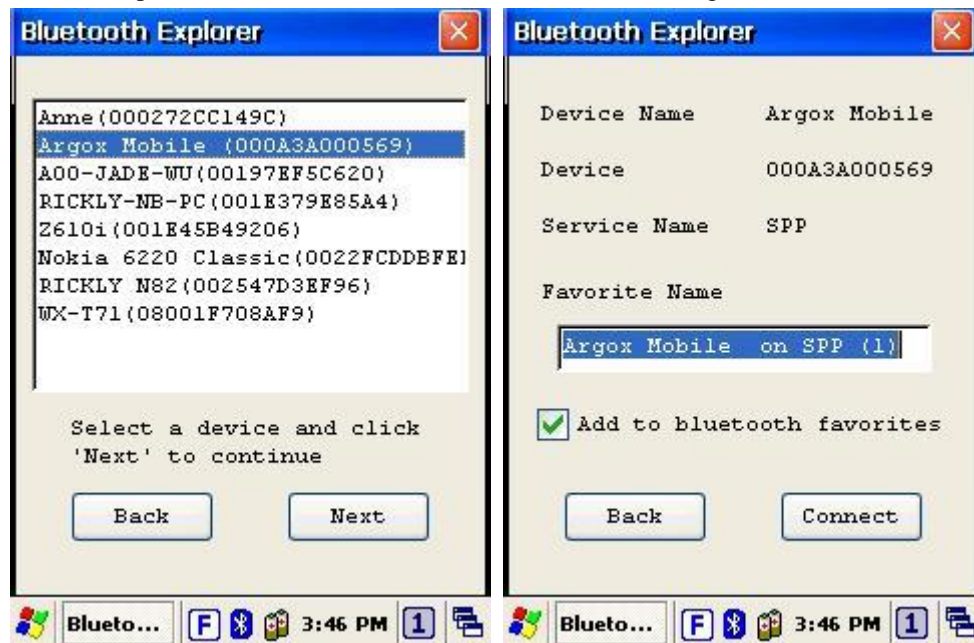

Figure3-21

3.8.9 After press Connect button, it will appear a connection with SPP mode like Figure 3-22.

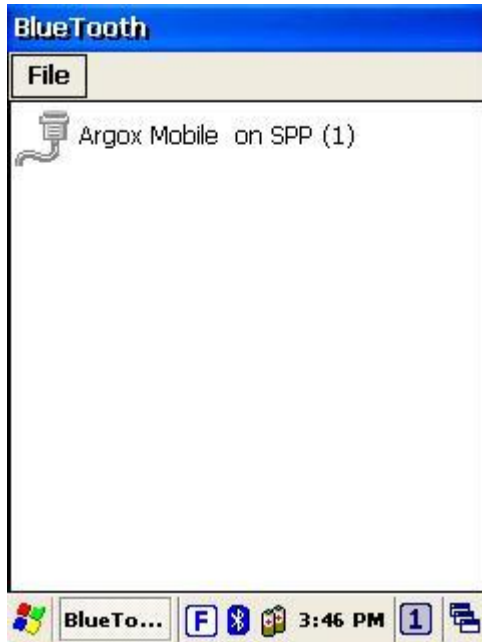

Figure 3-22

3.8.10 Third function is File Transfer like Figure 3-23

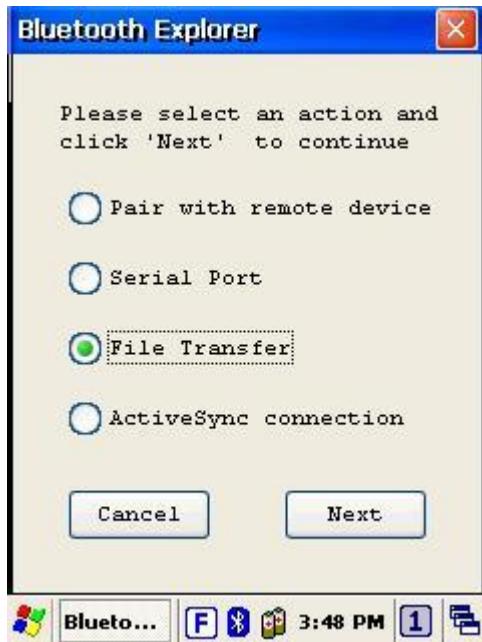

Figure 3-23



3.8.11 After press next button, it will start to search device and it needs to enter pin code like Figure 3-24

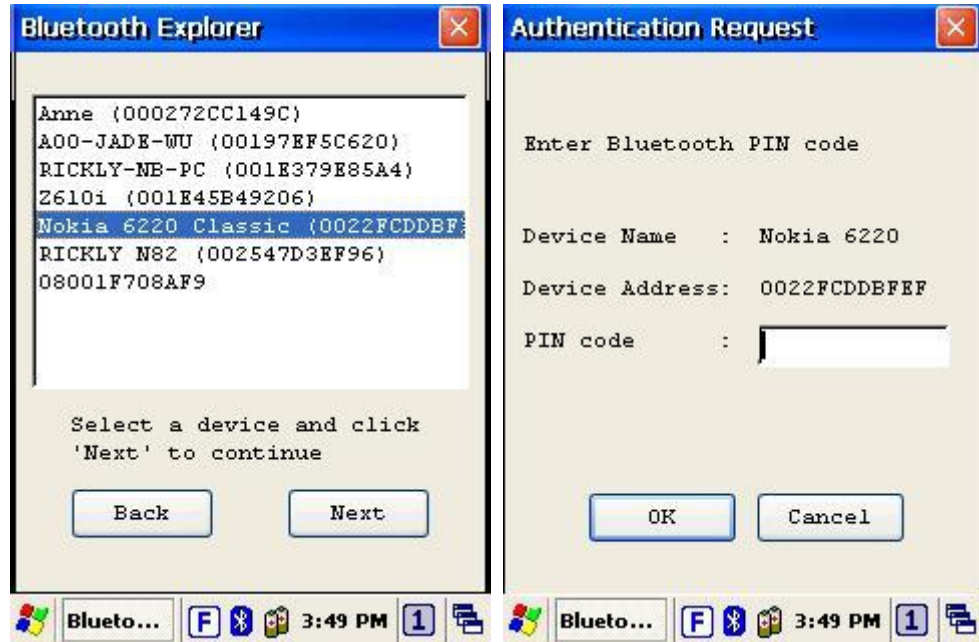

Figure 3-24

3.8.12 After checking pin code with the connect device. PA-60 will enter FTP mode like Figure 3-25.

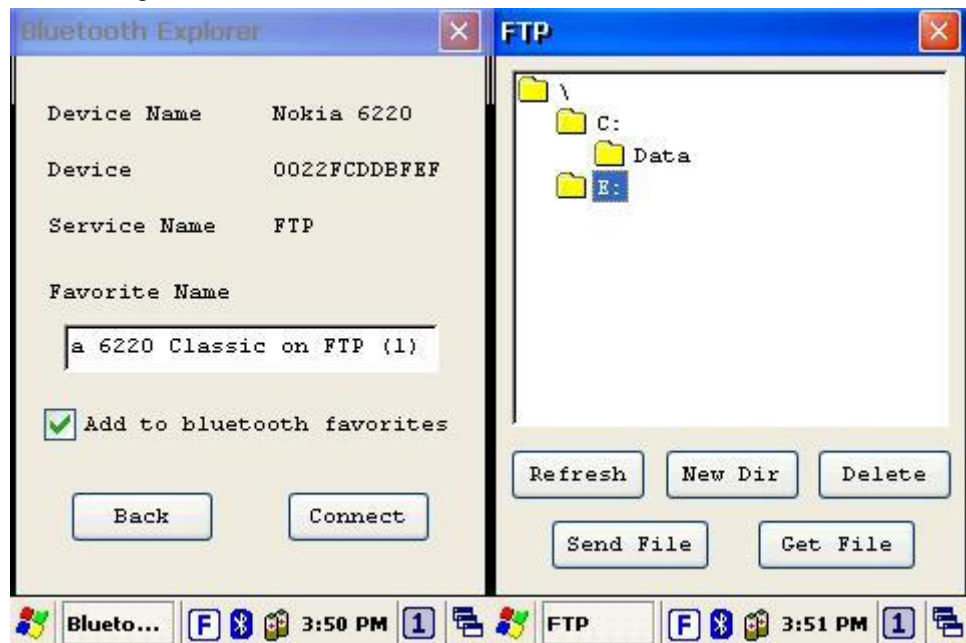

Figure 3-25

3.8.13 On Bluetooth manager screen, it will add a FTP connection like Figure 3-26.



Figure 3-26

3.8.14 The latest function is ActiveSync connection. The function can connect with computer via ActiveSync.



Figure 3-27

3.8.15 After press next button, it will start to search device.

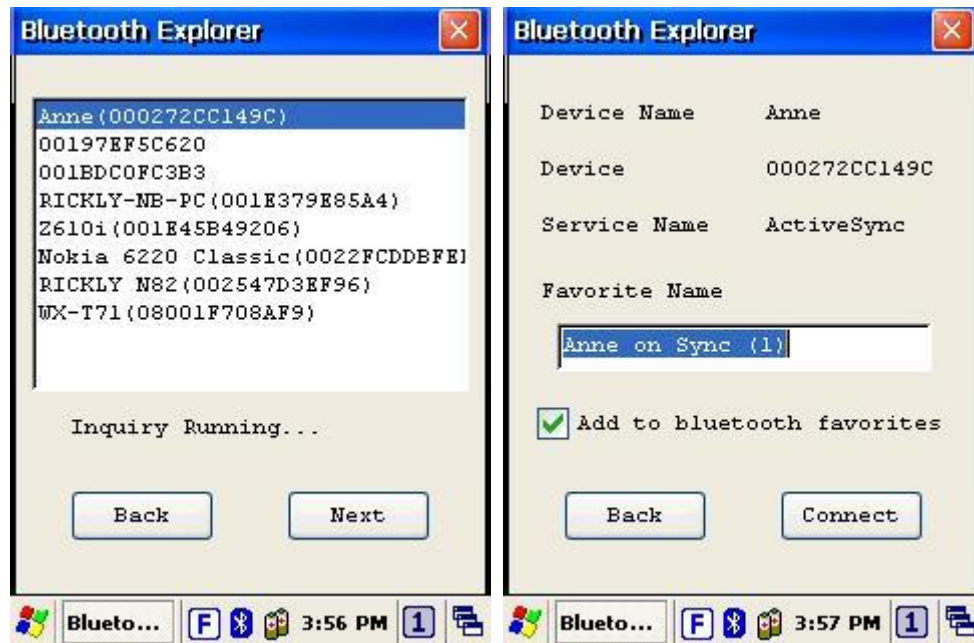

Figure 3-28-1

Figure 3-28-2

3.8.16 PA-60 will add an ActiveSync connection on Bluetooth manager screen. It will synchronize with computer.

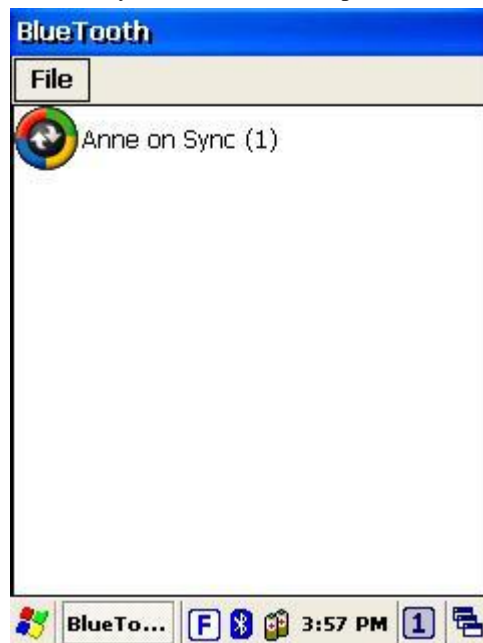

Figure 3-29

---

### 3.9 WLAN configuration step

For models using the 802.11 b/g/n radio, you can find information about the applet for radio configuration: <http://http://www.summitdata.com/SCU.html> .

3.9.1 Please enable Wi-Fi first like Figure 3-30-1. After enable Wi-Fi, summit icon appears as below. Figure 3-30-2

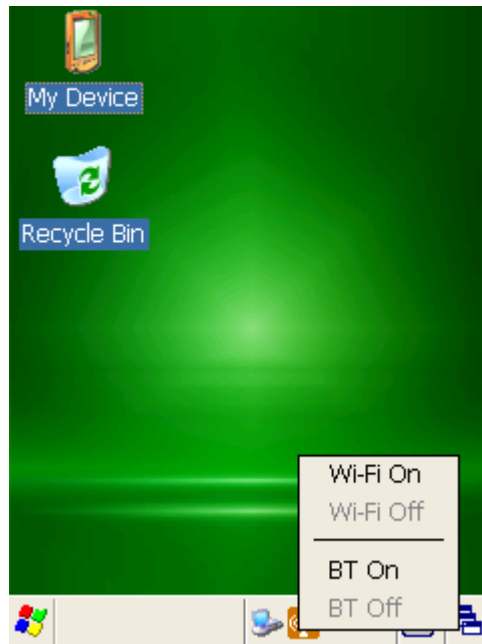

Figure 3-30-1

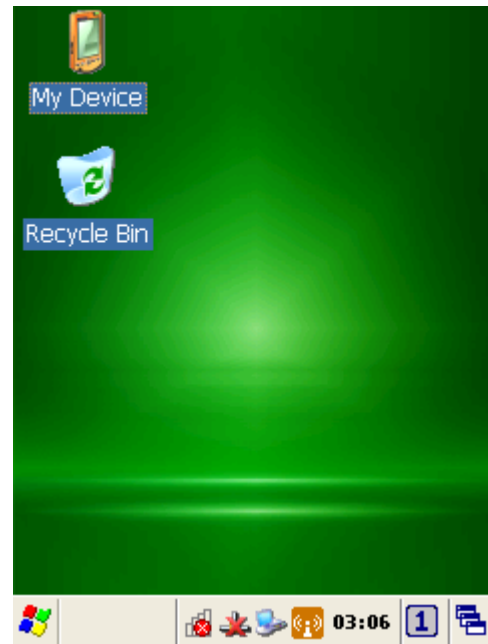

Figure 3-30-2

---

## 4 Scanning

The PA-60 has an integrated CCD scanner that reads all major bar code labels with excellent performance. The trigger key is located in the middle of the unit. Press this key to activate the CCD scanner.

### 4.1 Scan Configuration

When it is necessary to change the default barcode symbology for a different application, use **Scan Configuration** to change default symbology, place delimiter characters behind scanned data, and save the settings.

Run this program from **\Programs\Scanner\Scan Configuration.exe** which is also accessible via “**Setting\Control Panel**” on the Start menu.

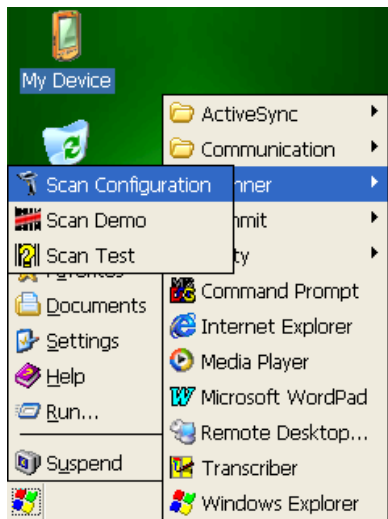

Figure 4-1-1 Scan Configuration

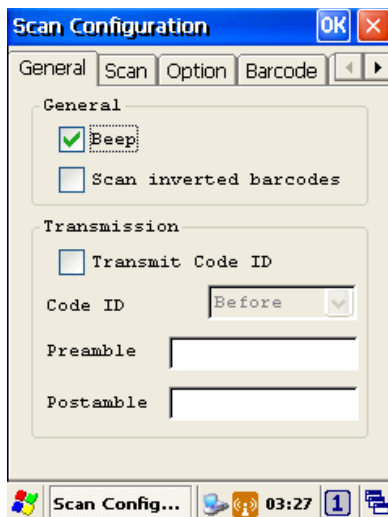
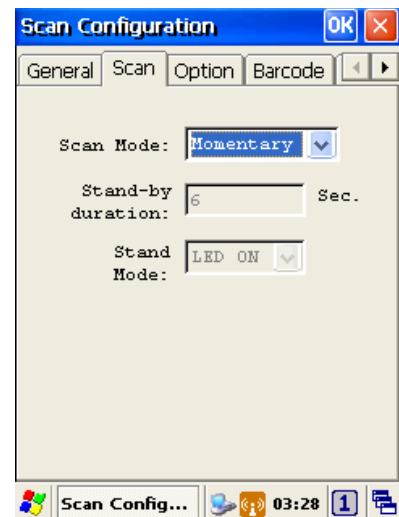

Figure 4-1-2 Scan Configuration



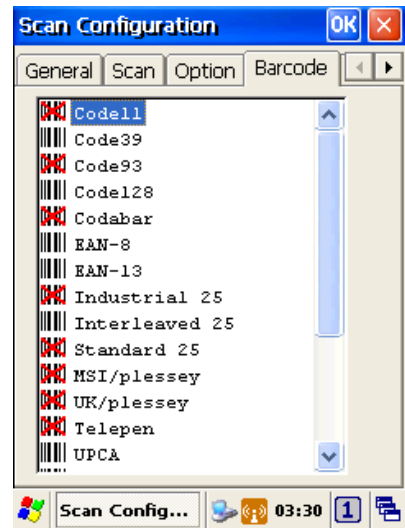
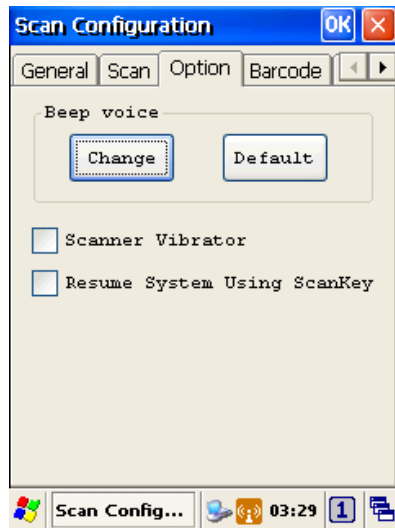

Figure 4-1-3 Scan Configuration

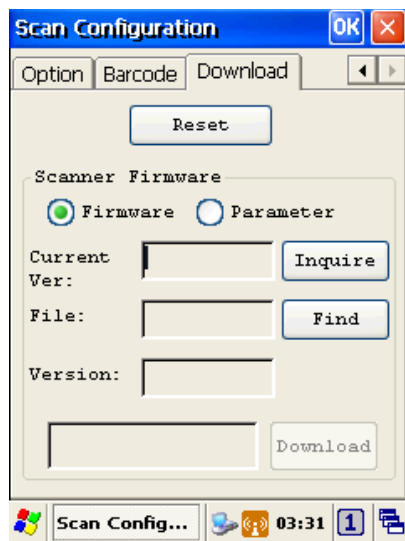

Figure 4-1 -4 Scan Configuration

After you change settings, go to the “Setting” page and press the “OK” button to configure, or press “Reset” to return to the scan default settings. The “Download” page allows you to update scan firmware.

---

## 4.2 Scan driver

Scan driver lets you put data into Microsoft WordPad. Open scan driver and the scan module

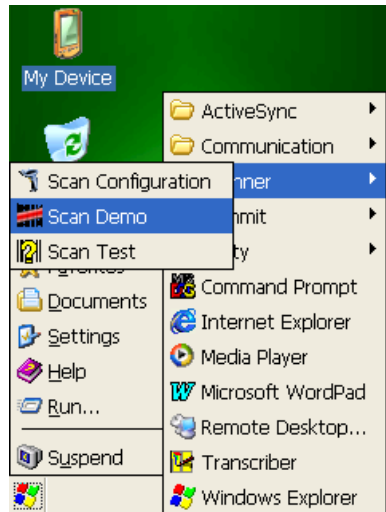

Figure 4-2-1 Scan Demo



Figure 4-2-2 Scan Demo

powers on the scanner. You can then scan barcode. To turn off the power, press “**Exit**” on the task bar.

---

### 4.3 Scan test

The PA-60 has a built-in Scan Test.exe program that allows you to test the barcode scan function. Scan Test.exe is located in directory **\Programs\Scanner\Scan Test.exe**.

This program shows barcode type and barcode data when pressing the “Scan” key.

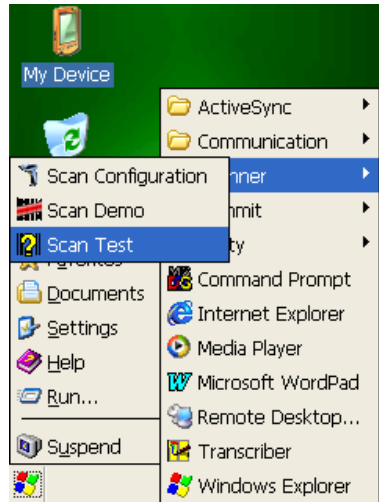

Figure 4-3-1 Scan Test

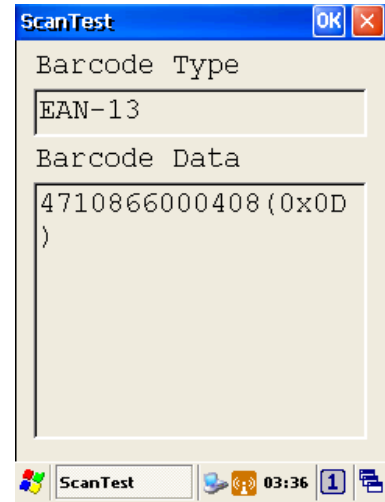

Figure 4-3-2 Scan Test



---

## 4.4 Reading barcode

<b>Note:</b>	<ul style="list-style-type: none"><li>◆ Observe handling precautions.</li><li>◆ Make sure the mobile computer is installed according to instructions.</li><li>◆ Never remove the main batteries or battery pack while the mobile computer is turned on. Doing so can cause loss of data in the mobile computer.</li><li>◆ Avoid looking directly into the LED light beam emitter, or pointing the LED light beam directly into someone's eyes.</li></ul>
--------------	--

Position the LED light beam over the bar code from margin to margin and pass the scanner downward over the bar code, as shown in the scan position illustration

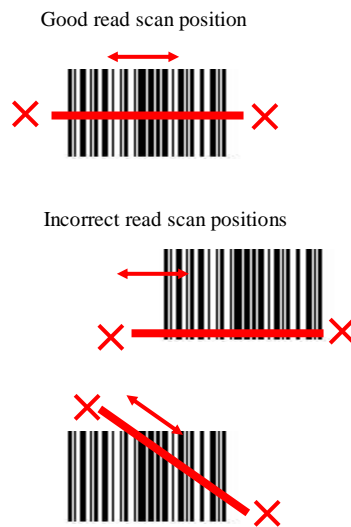



Figure 4-4 Scan Test

The scanning sequence is defined by the user's application. A typical sequence is:

- Point the mobile computer at the barcode and press the Trigger key .
- Point the LED lightbeam at barcode as shown in the scan position illustration above.
- The scanner reads the barcode and the results are indicated.

A "Good Read" means that the scanner has effectively recognized and decoded the bar code. In most cases, the application program provides an indicator signal to indicate a good read.

If the read is incorrect, try again paying close attention to the instructions.

When reading a small bar code, decrease the distance between the mobile computer and the bar code. For larger bar codes, position the mobile computer so that the bar code fits into the LED light beam. When reading a very high density bar code, decrease the distance between the mobile computer and the bar code. For a low density bar code, increase the distance between the mobile computer and the bar code.

---

## 4.5 Barcode reading problems

When the barcode can not be read, try the following:

1. Change the angle between the barcode and the mobile computer.
  2. Change the distance between the barcode and the mobile computer.
- ◆ If the barcode is larger than the LED light beam, try moving the mobile computer a bit further away from the barcode.



---

## 5 Utilities

### 5.1 Function Key Setting

#### AP Settings Tab

To assign your favorite application program from F1 to F9 hot keys:

1. Choose F1, F2, F3 ... or F9 from pull-down list.
2. Tap “**Define**” inside the “**Function Key Setting**” applet.
3. Select the application program you want from program list, and then choose “**OK**”.
4. Tap the **Apply** tab to complete setting.
5. Tap the **Default** tab to return to default setting.

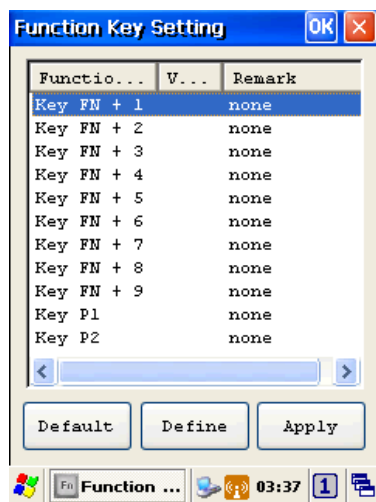

Figure 5-1 Function Key Setting

---

## 5.2 Timeout & Brightness

Backlight setting is a tool for changing the LCD backlight. If you wish to save power use this program to change LCD backlight settings. This application supports battery power backlight and external power backlight.

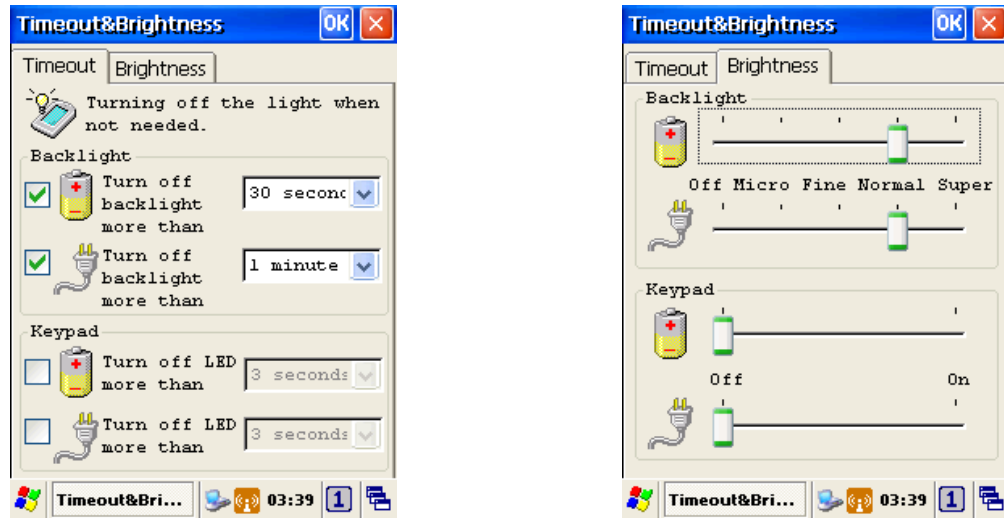

Figure 5-3 Timeout & Brightness

---

## 6 Software Applications

The PA-60 includes software applications such as Internet Explorer, Media player, Microsoft WordPad, Remote Connection, Transcriber, and Windows Explore.

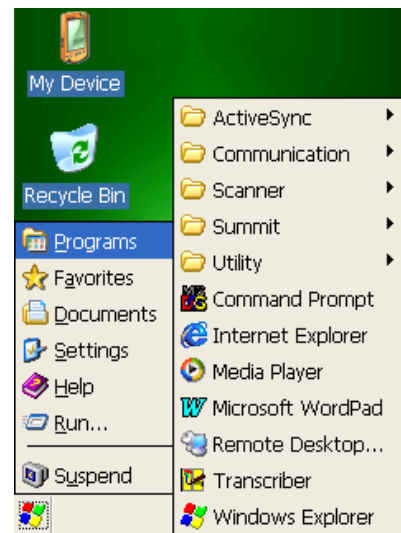

Figure 6-1 Programs Implemented

### 6.1 Internet Explorer

With Internet Explorer, you can view Web or intranet Web pages on your device. You will need to use WLAN to connect to an Internet Service Provider (ISP) or network.



Figure 6-2 Internet Explorer

---

## 6.2 Media Player

The PA-60 comes with Media Player for Windows CE 5.0 installed.

- Open Media Player by selecting Start → Programs → Media Player from the desktop.
- Select File → Open to open a new media file.
- Please refer to [www.microsoft.com](http://www.microsoft.com) for additional information and help with your Microsoft Windows Media Player.



Figure 6-3 Media Player

## 6.3 Microsoft WordPad

You can create and edit documents and templates in WordPad, using buttons and menu commands that are similar to those used in the desktop version of Microsoft Word. You can work with files Normal or Outline view.

WordPad documents are usually saved as **.pwd** files, but you can also save documents in other file formats, such as **.rtf** or **.doc**.



Figure 6-4 Microsoft Wordpad

## 6.4 Remote Desktop Connection

Using Remote Desktop Connection, you can log on to Windows Mobile computer Server and use all programs installed on this server. For example, instead of running Microsoft Pocket Word, you can run the desktop version of Microsoft Word.



FIGURE 6-5 REMOTE DESKTOP CONNECTION

---

## 6.5 Transcriber

### Features:

- Microsoft Transcriber is the natural handwriting recognition solution for your Windows CE device. It recognizes words from its integrated dictionary, and allows you to write in cursive, print or mixed handwriting.
- The **letter Shapes Selector** (note 1) is for optimizing recognition to your own handwriting style
- Transcriber works transparently in the background of all Windows CE applications providing handwriting input, while taking away no precious screen space.



Figure 6-6 Transcriber

## 6.6 Windows Explorer

Windows Explorer works almost the same on your PDA as it does on your PC. See the topics below for information about the difference in Windows Explorer on your device.



Figure 6-7 Windows Explorer

---

## 7 Communication

The Argox PA-60 lets you link to a host computer via RS-232 or USB port for data communication. This chapter gives an overview of the PA-60's communication capabilities.

### 7.1 ActiveSync

To exchange data between your desktop computer and the PA-60, Microsoft ActiveSync must be installed on your desktop computer.

With Microsoft ActiveSync you can:

- Transfer data
- Back up and restore PA-60 data.
- Add programs to and remove programs from the PA-60.

This chapter introduces Microsoft ActiveSync version 4.5 ActiveSync provides a user-friendly interface and it can be downloaded free of charge from Microsoft's Website.

### 7.2 Installing Microsoft ActiveSync

Before beginning installation, carefully read the following:

Because you will restart your computer during installation, save your work and quit all programs before you begin.

To set up your communication settings, a PA-60 serial cable is required to connect the PA-60 to your host computer.

If you run the Windows NT operating system with a service pack, you will be informed during setup that you may need to reinstall the service pack. Try connecting first, and if unsuccessful, reinstall the latest service pack.

#### **Basic PC specifications for the installation of ActiveSync are as follows:**

OS	Microsoft Windows XP/2000/ME/98, or higher version program than SP6 Windows NT Workstation 4.2
Application	To be able synchronize data such as email, calendar tasks and notes between OT-80 and a desktop or notebook, you need to have a higher version than Microsoft Outlook 2000
Browser	Microsoft Internet Explore 4.21 SP1 or higher
Hard disk	Free hard disk space more than 65MB (Actual required space is according to selected functions and your current system configuration)
Communication port	9 pin or 25 pin communication port (for adapter, 25-pin port is needed)
USB port (available only for Windows 98/Me/2000/XP)	
Graphic card	VGA graphic card or compatible video graphic adapter supporting resolution of 256 colors or higher
Keyboard	
Microsoft mouse or compatible input devices	
CD-ROM drive	



---

## Installation

Follow the installation procedure below to install Microsoft ActiveSync, connect your PA-60 to your desktop computer, and establish a partnership for synchronization (if desired):

1. Download the executable program “mswrd832.cnv” from CD. Execute this program.
2. Select the folder into which Microsoft ActiveSync will be installed. If you choose not to download into the displayed default folder, click the **Change** button.
3. After you’ve selected the folder, click **Next** to set up Microsoft ActiveSync. After you’ve installed Microsoft ActiveSync and restart your computer.

## 7.3 Connecting the PA-60 to ActiveSync

Connect the PA-60 to a desktop PC using a USB cable. Make the partnership between the desktop PC and PA-60 through ActiveSync, and then proceed with the synchronization of the desktop PC and PA-60. Use a USB cable to link the PA-60 to the desktop PC.

The table below shows available communication devices (USB, serial) according to operating system.

<i>Supporting operating system</i>				
Connection methods	Desktop PC OS			
	Windows 95	Windows 98	Windows 2000/XP	Windows NT
USB	Not available	Available	Available	Not available
Serial	Not available	Available	Available	Available

Connect a desktop PC and the PA-60 with a cable as follows:

4. Connect a USB cable to the USB port of the desktop PC.
5. Insert the cable into PA-60 mobile computer. The PA-60’s PC connection program runs automatically and Microsoft ActiveSync in the desktop links them together.
6. To set up a connection, the “**New Connection**” set-up wizard appears on the desktop computer. Set-up methods are discussed in the following section.

---

## 7.4 Setting up a Partnership

When you first connect the PA-60 to the desktop computer, Microsoft ActiveSync asks if you are going to set up a partnership. Once the partnership set-up is finished, you can synchronize data with the PA-60. While the PA-60 can set up the partnership with two desktop computers, email messages can be received only through one computer.

To set-up a partnership:

1. Insert the PA-60 into the docking cradle connected to the desktop PC. It automatically starts the New Partnership wizard on the desktop PC screen. When it asks if you would like to set up the partnership, select Yes and click **Next**.



Figure 7-1 Set up a Partnership

2. Key in the name of the device (for instance, Windows CE1, MyPDA, etc.) then click **Next**.
3. If the PA-60 has already set up a partnership with another desktop computer but no longer uses it, select “**Yes, I want to synchronize with only this computer**” in the dialog box named “Select Number of Partnerships.” It removes the other partnership set-up so that the PA-60 no longer recognizes the previous desktop computer. Click **Next**.
4. The window for setting up synchronization appears. To synchronize specific kinds of data, select the item then click **Next**. Most popular items include Calendar, Contacts, Tasks, and Inbox. We recommend you select and use these items. In the item list, two types of email items are available: Inbox and Inbox. While the inbox is an email program provided by Microsoft Corporation, Inbox is offered by a software provider. In the PA-60, Inbox offers special functions such a connecting to “Today” set-up function button, etc.
5. Complete the set-up process by clicking **End**.  
When the partnership set-up between desktop PC and PA-60 is completed, ActiveSync automatically synchronizes the selected data.

---

## 7.5 Connecting the PA-60

### 7.5.1 *Synchronizing Data*

If the Microsoft ActiveSync window appears in the desktop PC, click the option icon and “Sync options,” “Sync Mode,” and “Rules” appears.

“Sync options” lets you select an item to synchronize. “Sync Mode” enables you to choose synchronization methods. According to the selected mode, there are 3 methods:

1. **Continuously while the device is connected:** (Default) Connect the PA-60 to the desktop computer. ActiveSync immediately starts synchronization and synchronizes according to the user’s input of changes in the desktop computer or PA-60.
2. **Only upon connection:** Connect the PA-60 to the desktop computer. ActiveSync immediately starts synchronization. If you want to carry out the synchronization after the first synchronization on a manual basis, click Sync.
3. **Manually:** ActiveSync will not run automatically. For synchronization, click Sync.

Synchronization is the process of updating PA-60 and desktop PC after comparing data. Any files including personal organizer management data, email message, etc. in the PA-60 can synchronize with files in the desktop PC.

### 7.5.2 *Solving Problems during Synchronization*

When a problem occurs during the synchronization process, it is marked as “Not completed” in both ActiveSync and the PA-60. You can solve the problem at your convenience.

There are various reasons for failure of ActiveSync to carry out synchronization. For instance, if the computer cannot access Microsoft Outlook information due to a server failure, ActiveSync cannot synchronize items such as Calendar, Contacts, Tasks, and Inbox. Or else the problem stems from changed items in the PA-60 and the desktop PC.

By modifying the problem-solving settings, you can have ActiveSync not register the problem as “not completed item” instead, if you select the PA-60 or desktop PC as default version, ActiveSync automatically updates the information contained in the other computer. If you do not want to solve the problem manually, you can modify the problem-solving setting to have ActiveSync always use the PA-60 or desktop PC version.

1. Click options then click tap Rules.
2. Select the item of choice from Conflict Resolution.

For those items that cannot complete synchronization without user intervention, ActiveSync and portable device display them as “not completed”.

1. Connect PA-60 to the desktop computer and carry out synchronization.
2. When there are no complete items, click Resolve in the Tools menu.
3. Follow instructions on the screen. The dialog box differs depending on the problem.

---

### 7.5.3 *Searching PA-60 Contents from a Desktop PC*

If the PA-60 is connected to a desktop PC, you can use ActiveSync on the desktop PC to see the contents of the PA-60. Click Explore from the file menu of ActiveSync. The content of the PA-60 is displayed on the window of Mobile Device.

Use ActiveSync to see the files in the PA-60 as follows:

1. Connect the PA-60 to the desktop PC
2. Explore in ActiveSync. It open the Mobile Device folder in Windows Explorer
3. Applying the same method, check the files in the device in other Windows Explorer

If you double click folders in Mobile Devices, it may take several seconds to open the folder.

While browsing the folders, you can carry out cut, paste, and copy by dragging file icons. In the desktop PC, you can get access to the content of the PA-60 using Windows Explorer. If you choose Files during the partnership set-up, **Windows CE My Documents** is created in the My Documents folder. If you use **Windows CE My Documents** in the desktop PC, you can easily access the My Documents folder in the PA-60.

---

## 8 Overview of Microsoft Windows CE 5.0

This chapter describes Microsoft Windows CE 5.0, the operating system for the PA-60

This introduction to Microsoft Windows CE 5.0 includes:

1. How to use the main Windows
2. How to use a taskbar
3. How to use settings

### 8.1 Main Windows

When you turn on PA-60, you will see the main Windows of Window CE 5.0, which is similar in appearance to Windows XP. The main window consists of a background screen and taskbar.

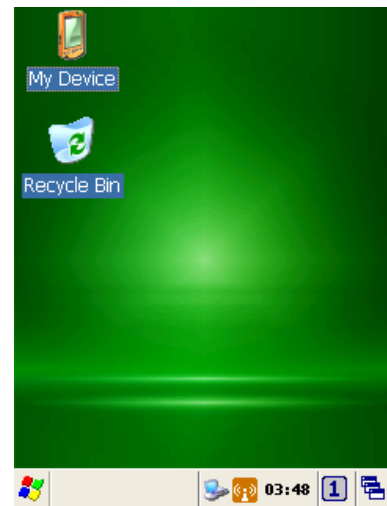

Figure 8-1 Main Window

The screen shows short cut icons for the main programs of Microsoft Windows CE 5.0. A description of the icons follows:

#### **My Device:**

Shows the internal configuration of the PA-60 and the folders and files it contains.



Figure 8-2 My Device

---

### Recycle bin:

Completely delete or restore files and data. This folder saves deleted files from Windows Explorer or the background screen. You can completely empty or restore files in the recycle bin.

---

**Caution:** Once you have emptied the recycle bin, you cannot restore the files and data previously in the recycle bin.

---

### Taskbar

Windows CE 5.0's taskbar is designed to be simple and user-friendly. The picture below shows the configuration of the taskbar.



### Start Icon

Start icon is the starting point for the PA-60 program. If you point at the start menu with the stylus pen, you can see various menus including program, bookmark, document, setting, help, and operation. If you choose each menu, detailed executable programs appear as in the picture below. If you choose and press, you can run the program of your choice. Windows CE 5.0's start menu is similar to that of Windows on a desktop PC.

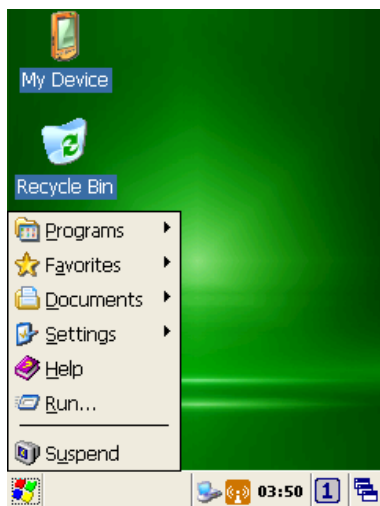

Figure 8-3 Start Icon

---

## 8.2 Taskbar

Taskbar shows a variety of information including keying in characters, battery, network connection, status of running programs, etc.

If you press and hold the taskbar with the stylus, the right button function menu appears.

The right button function menu is composed of task manager and features. If you select the taskbar and start menu feature, general option menus such as “always place above,” “automatic hiding,” “Watch display”, etc. You can choose the check box of desired options and use them.

The following explains the function of icons appearing on the taskbar.



Transcriber:

When you want to key in characters when making a document or setting, start Transcriber. Using the stylus to draw characters you want on the input panel, this program recognizes the characters and transform them into typeface characters. To start the Transcriber, run the program as the following order: start → program → Transcriber.

The picture below shows how the Transcriber works in keying in characters on Microsoft Word Pad. When Microsoft Transcriber is running, you will see the “hand with a pen” icon located in the taskbar. When Microsoft Transcriber is active the “hand with pen” icon shows a dark background.

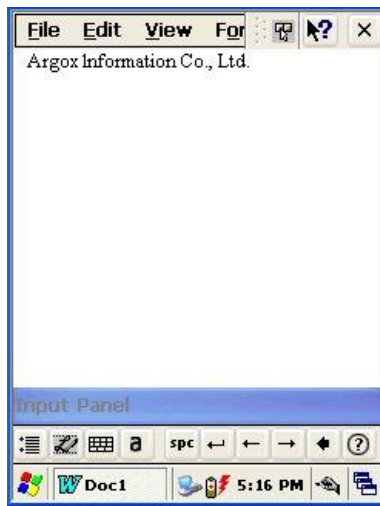

Figure 8-4 Transcriber



Keyboard: Press this icon to activate the keyboard input



---

### Upper / lower case Selection:

Press this icon to select upper and lower case letters. If you select upper case, capital letters and characters appear on the number key pad. It serves the same function with the Shift key.



### Hot key Selection:





If you use hot key such as “z”, “x”, “c” and “v”, you can carry out Cancel, Cut, Copy, and Paste, respectively. To change the features of the soft keyboard, select keyboard in Go to Start → Setting → Control Panel → Input Panel and click the option you wish to set up.

### **Input Method:**

To carry out character key-in using [keyboard] input, press keyboard icon on the taskbar. You can also key in by activating Transcriber in the following order: Start → program → Transcriber. Press the keyboard once, it appears on the screen. Press again and it disappears.

### **Status Indicator Icon:**

The following is a list of icons that appear in the taskbar’s status area.

Icon	Description
	Battery capacity is low
	Battery is charging
	Linked to desktop PC through USB
	Show network connection status.
	Show Internet connection status via WLAN



---

### 8.3 Setting up the PA-60

You can set up various configurations of the PA-60 such as date/time, Network, Display, Volume, Power, System, etc. at the control panel.

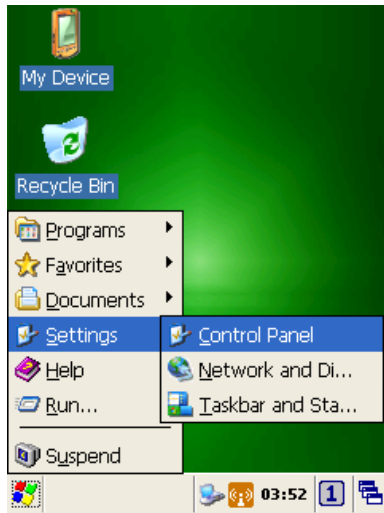

Figure 8-5 -1 Control Panel

If you press Start → Setting → Control Panel, the control panel window appears. In the View option in the menu, you can change the view mode into large icons, small icons, details or to arrange icons. The control panel appears as below:



Figure 8-5-2 Control Panel



Figure 8-5-3 Control Panel

---

### 8.3.1 Certificates

Application programs use certificates to ensure reliability and safe communication.



Figure 8-6 Certificates

Authorized certificate providers issue certificates that are valid for a specified period. Windows CE 5.0 manages several certificate storages.

1. Select Go to Start → Setting → Control Panel.
2. Double click a certificate to run.  
Select certificate storage for browsing or correcting through the storage tap list.  
**My certificate:** This saves the user's personal certificate to identify the user.  
**Other certificate providers:** Middle certificate providers establish chains of reliability.  
**Reliable certificate providers:** Includes the top quality certificates.
3. To add certificates or secret keys in the selected storage, press the **Bring** button then select the way to bring certificates or keys. You can select them from files or a smart card.
4. To see details of selected certificates such as extension, expiration date, etc. press the **View** button.
5. To delete the selected certificate from storage, press **Delete** button.

---

### 8.3.2 *Date/Time*

This screen sets date, time, standard time zone, watch and alarm.

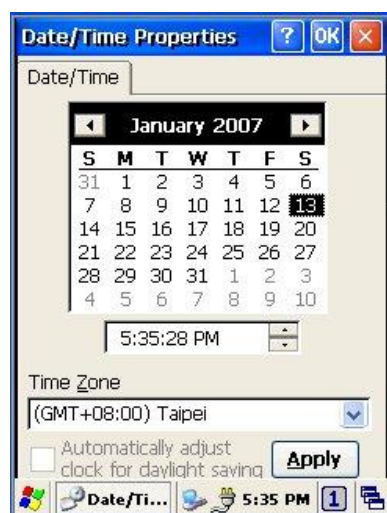

Figure 8-7 Date/Time

#### **Date/Time**

You can set standard time zone, year, day and time. Set as follows:

1. Press the down arrow in the standard time zone until it reaches your location. If the previously set value is appropriate, move on to the following.
2. Select year and month in the calendar. If the current year is not correct, press year and adjust. You can select the month using left and right arrows or the monthly tab that pops up when pressed.
3. Press the correct date on the calendar.
4. Set time by keying in correct time in the current time box. The box shows AM/PM: hour: minutes: second. Press each and adjust time with arrows on the right.
5. Press **Apply** to save the changes. Confirm if the time is correct.

---

### 8.3.3 *Dialing*

#### **Dialing Properties**

1. In the **When dialing from** list, select the “**Location**” where you want to change settings.
2. To create a new location, select “**New**”. Enter the name of the location, and then select “**OK**”
3. Enter or edit the area code and local country code as needed.
4. In **Dial using**, select “**Tone dialing**” or “**Pulse dialing**”. Most phone lines are tone.
5. To automatically disable call waiting, select “**Disable call waiting by dialing**,” select the appropriate number sequence in the list, or enter a new sequence.

#### **Editing dialing patterns**

1. Using the codes listed, revise the dialing patterns as needed.

- 
- Notes:**
- 9.1** If you need to use characters other than the ones listed here, use manual dialing. Hyphens and spaces in dialing strings are ignored.
  - 9.3** Some modems may not respond to the some characters, even though your device lets you add them to the dial string.
- 



Figure 8-8-1 Dialing Properties



Figure 8-8-2 Dialing Properties



Figure 8-8-3 Dialing Properties

---

### 8.3.4 *Display*

This screen lets you set the wallpaper image of the PA-60, change the color of the background screen, or change the backlight setting. Call up the right button menu and select “properties” and you can check the Display Properties window.

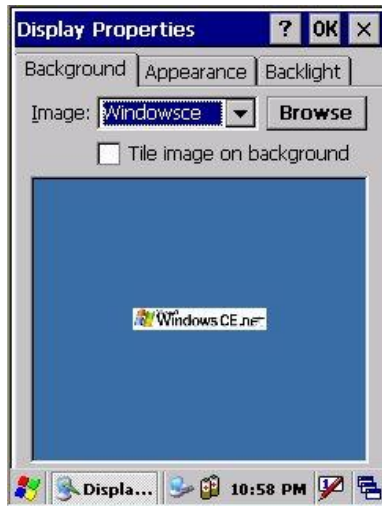

Figure 8-9-1 Display Properties



Figure 8-9-2 Display Properties

#### **Desktop**

Change the desktop image of the background screen as follows:

1. Select the desktop with a tap.
2. Select an image to use for your background from the image list. The image list shows you image files in a Windows folder. If you want to use images from other folders, click Search.
3. To arrange the desktop image in a checked format, choose a checked pattern.

#### **Setting**

You can adjust the contrast and brightness of the LCD screen.

---

### 8.3.5 *Hot Function Key*

Please refer to Function Key Setting above.

### 8.3.6 *Input Panel*

You can set up the input method and options.

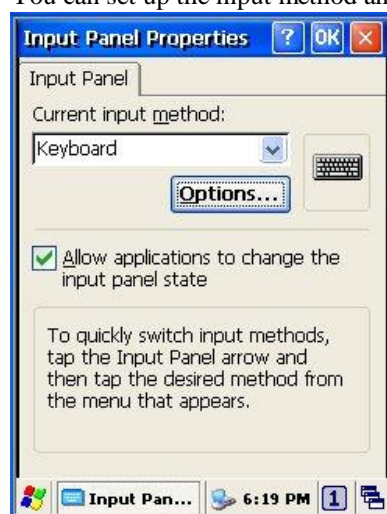

Figure 8-10-1 Input Panel Properties

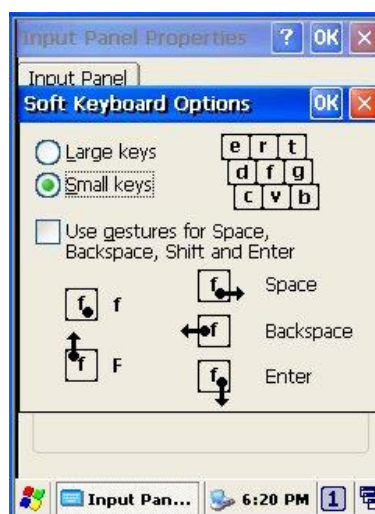

Figure 8-10-2 Input Panel Properties

1. Select keyboard and press Options. The Soft Keyboard Options window appears.
2. Select the size of the keys.
3. To use gestures for Space, Backspace, Shift and Enter, click the gestures check box.
4. Click OK to save the changes.
5. Select the handwriting recognition as the current input method and click Options. The handwriting recognition features window appears.
6. Set time needed to recognize handwriting.
7. Click OK to save the setting.

### 8.3.7 Internet Options

This setting allows you to specify the home page, clear cache, specify connection, define the security and make advance settings of the IE browser.

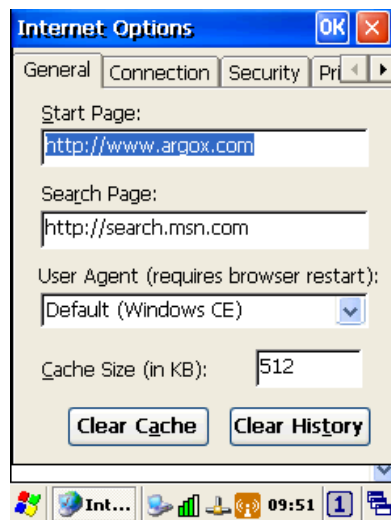

Figure 8-11-1 Internet Options

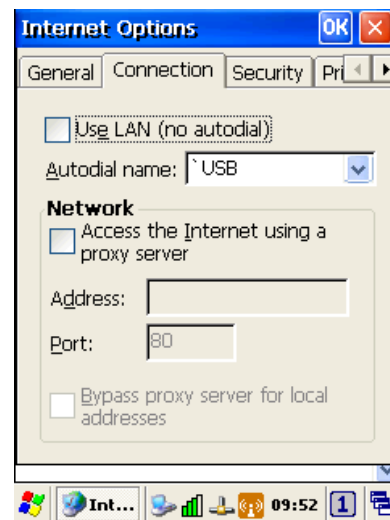

Figure 8-11-2 Internet Options



Figure 8-11-4 Internet Options



Figure 8-11-4 Internet Options

#### General

Click the General tab.

1. Define your own start page and search page on the tab.
2. It also can set cache size.
3. Click Clear Cache button, it will clear data in cache.
4. Click Clear History button, it will clear browse history.

---

## Connection

Under Connection page, specify the network connection you want the browser to connect to the network.

To use a proxy server, click [Access the Internet using a proxy server] check box and enter the proxy address and port.

## Security

Under Security page, specify the security option for your browser.

## Privacy

Under Privacy page, specify the cookies setting include of privacy level.

### 8.3.8 *Keyboard*



Keyboard

#### Repeat Tab

1. To change the amount of time between taps before repetition starts, adjust the **Repeat delay** slider
2. To change the repeat rate, adjust the **Repeat rate** slider.
3. Test your new setting.
4. Tap “**OK**” to exit the “**Keyboard**” Tab.

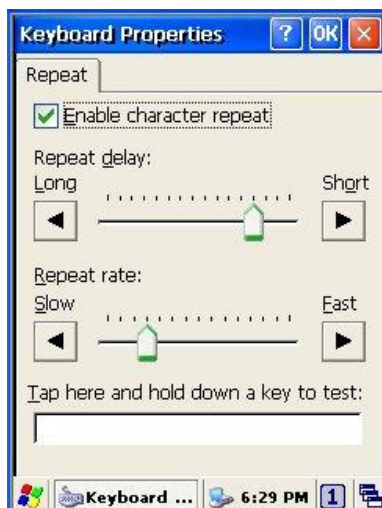

Figure 8-12 Keyboard Properties



---

### 8.3.9 *Mouse*



Mouse

1. Double-click the checkerboard grid at a comfortable speed.
2. Double-click the Test icon to test your setting.
3. Tap “**OK**” to exit the Mouse tab.

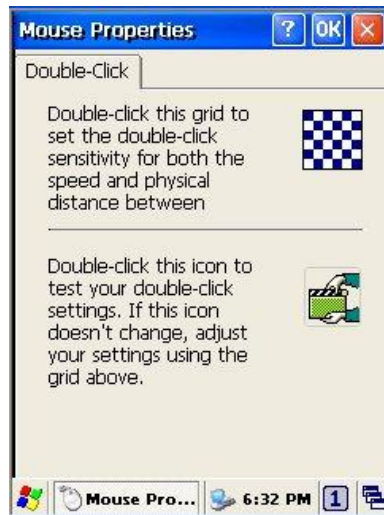

Figure 8-13 Mouse Properties

### 8.3.10 *Network and Dial-up Connection*

You can directly link to the network via network (Ethernet, LAN) or phone (modern) connection. You can send or receive emails or access available files on the network server or search the Internet or Intranet.



Figure 8-14 Network connection

---

### 8.3.11 *Owner*

This function lets you set the PA-60 to display user information at start up, add information on the user, and set up a network ID.

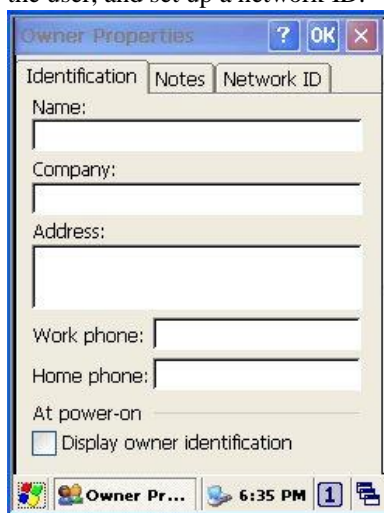

Figure 8-15 Owner Properties

#### **Identification**

Enter information such as name, company, address, company phone number, home phone number in the user information tab. To display the owner information on the start screen for system start, click the “Show User Information” check box.

#### **Notes**

Enter additional user information or other information in the Notes box. To show notes on the initial screen when the system starts, click “Show User Information” check box.

#### **Network ID**

Windows CE 5.0 gains access to Network resources using the owner information. Enter the information provided by Network manager such as user name, password, and domain.

---

### 8.3.12 *Password*

You can set a password to keep unauthorized users from using the PA-60.



Figure 8-16 Password Properties

To set up a password:

1. Select the password setting tab.
2. Enter the password in the password box.
3. Re-enter the password in the password confirmation box.
4. To enable the password protection when the system starts, click the “Use Password for While System starts” check box.

If you touch the screen with a stylus pen to input the password in the initial screen, a keyboard appears. After keying in the password, press enter on the keyboard to go to the main screen. You may encounter a request to enter the password again on the initial screen if you have turned off the PA-60’s power after activating password or have done a software reset. If you forget the password and cannot boot the system you may have to do a hardware reset. A hardware reset erases all files, data, as well as programs. Please consider using a password that is easy to remember and leave a record easy to access. To deactivate a password, delete the password in the password feature window.

---

### 8.3.13 *PC Connection*

You can set up a PC connection to synchronize the device with a desktop PC or other devices. You can set desktop USB and serial port connections. The following is the procedure required for changes in PC connection.

Begin with Windows CE 5.0. The PA-60 basically supports the Internet functions via USB. If you set up a partnership with PC during ActiveSync, it provides “USB@PocketPDA” link items that enable an Internet connection through the cradle:



Figure 8-17 PC Connection

1. Create a new connection in Go to Start → Setting → Network. Choose the direct connection as connection format. For detailed information, refer to the “Network and Dial-up Connections” section.
2. Select Go to Start → Setting → Control Panel → PC connection.
3. Select Connection Change icon.
4. Select the connection mode.
5. Connect to a desktop PC.

To connect the PA-60 to a desktop PC, you must have Microsoft ActiveSync 3.7 or higher on your desktop PC.

### 8.3.14 *Power*

Please refer to the previous section on Power Management.

---

### 8.3.15 *Regional Settings*



Figure 8-18 Regional Setting Properties

You can set up region, numbers, currency, time, and date.

1. Select Go to Start → Setting → Control Panel.
2. Open regional setting icon.
3. Select the tab for information to change.
4. Select the preferred option. Available features are dependent on which region you have chosen in the region tab.

---

### 8.3.16 *Remove Programs*

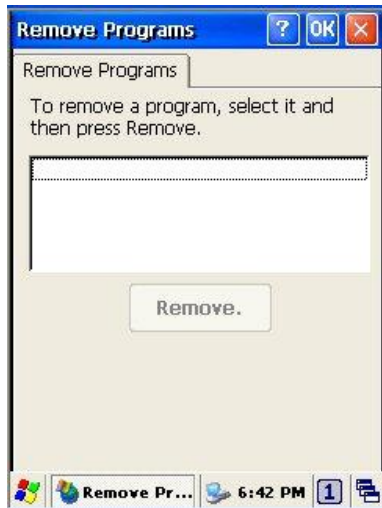

Figure 8-19 Remove Programs

To remove installed programs:

4. Select Go to Start → Setting → Control Panel.
5. Open the Program removal icon.
6. Select the program to delete from the program list.
7. Click Delete.

---

**Note:** You can only remove programs installed in RAM. If you cannot delete a program, see detailed information in Windows CE Help on the PA-60 or in the program documents.

---

---

### 8.3.17 *Scan Configuration*

Please refer to the previous section on Scan Configuration.

### 8.3.18 *Storage Manager*

Storage manager allows the users to check the information of the SD/Flash storage and format, dismount or make new partition on SD card.

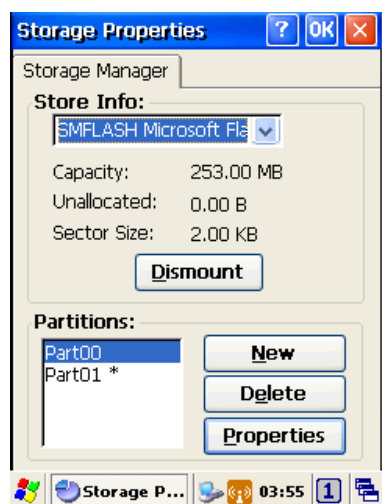

Figure 8-20 Storage Properties

1. Select the flash or SD card form the storage information dropdown list.
2. To format the partitions of the selected disk, click Properties icon and choose Format icon.
3. After clicking the Create New icon, key in the new partition names. The system automatically creates new partitions to set up.
4. To dismount a partition, select a partition to delete then click the Properties icon and press the dismount button.
5. To see the features of the selected partitions, click the Properties icon.

---

**Caution:** Formatting a disk erases all data, files, and programs.

If you insert external extension memory SD\*MMC memory cards, SD\*MMC memory shows as “SD Memory Card”.

---

---

### 8.3.19 *Stylus*

This screen sets double-tap sensitivity and calibration.

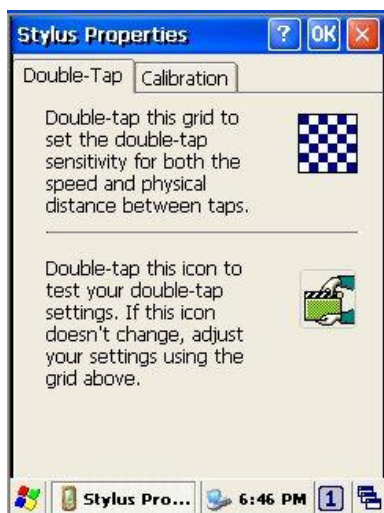

Figure 8-21 Stylus Properties

#### **Double Tap**

To set double-tap sensitivity:

1. Select Go to Start → Setting → Control Panel.
2. Activate the stylus and select Double Touch-Tap. Tap the grid and the color of the grid changes.
3. It automatically records the speed of the Double-Tap.

To test the sensitivity of double touch:

1. Select Go to Start → Setting → Control Panel.
2. Activate the stylus and select Double Touch-Tap.
3. Touch the icon twice. The icon changes.
4. If the icon does not change, adjust the setting using the grid above.

#### **Calibration**

If the PA-60 screen does not respond properly, adjust the screen with the calibration function.

To start calibration:

1. Select Go to Start → Setting → Control Panel.
2. Activate the stylus and select calibration tap.
3. Press calibration again and the adjustment process begins.

---

**Caution:** Sometimes touching the screen with the stylus triggers the right mouse function. You can solve this problem by adjusting the double touch sensitivity.

---



---

### 8.3.20 *System*

The system properties window displays device information such as system, memory, the names of devices, copyright and version details.

General information contained in the window includes operating system data such as software version, processor, memory, user information, etc.



Figure 8-22 System Properties

The memory of the PA-60 is used for data storage and programs. Basic memory capacity is 128MB. You can set the size of the memory cache used for running programs or storing data.

#### **To set the memory:**

1. Select Go to Start → Setting → Control Panel.
2. Run the system and select the memory tab.
3. The blue part of the slider indicates the available memory capacity.
4. Move the slider. Left of the slider is storage memory while the right is program memory.
5. As memory storage capacity increases, you can save more data and files. If you find a program is running too slowly, move the slider to the left to secure more program memory capacity.

The device name indicates the PA-60's partnership relation when linked to the desktop through ActiveSync.

#### **To set up device ID:**

1. Select Go to Start → Setting → Control Panel.
2. Run the system and select the name of the device.
3. Enter the name of the device and its details.

### 8.3.21 *Terminal Server Client Licenses*



Figure 8-23 Terminal Server Client Licenses

### 8.3.22 Timeout and Brightness

Please refer to the previous section on Timeout and Brightness.

### 8.3.24 Volume and Sound

Adjust volume and select sound.

#### **Volume**

To adjust the volume of the system:

1. Select Go to Start → Setting → Control Panel.
2. Open volume and sound icons and select the volume tab.
3. Press the left / right arrow icon or move the slide bar to adjust a volume.
4. Click all items to activate the sound such as event (warning, system events), application program, reminder (Alarm, notice).

---

## Sound

To set the sound:

1. Select go to Start → Setting → Control Panel.
2. Open volume and sound icons and select volume tab.
3. Select an event from the event list.
4. Select a sound from the event sound list.
5. To remove the sound from the selected event, choose (None).
6. To save the changes in another scheme, select save in another name and name the sound scheme.
7. To remove the sound scheme, select the scheme and then Delete.

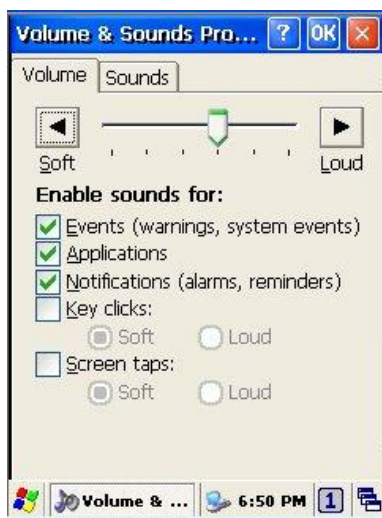

Figure 8-24-1 Volume & Sounds



Figure 8-24-2 Volume & Sounds

---

## 9 Troubleshooting

This chapter contains information on solving problems you may encounter when using the mobile computer and/or cradle. If problems occur, first carry out general checks before comparing the problem with the descriptions in this chapter.

### 9.1 General Checks

- Make sure everything is installed properly
- Check the power supply (including the main battery or battery pack in the mobile computer) of all devices
- Is the reading window of the mobile computer clean?
- Is the interface connector properly connected with the cable?
- Are the bar code labels readable, e.g. not damaged or poorly printed?

If the problem persists after these checks are performed, please check the problem descriptions below. If the suggested solutions below do not resolve the problem, please contact your local supplier or Argox for technical support: <http://www.argox.com>

If the PA-60 mobile computer needs repair, please ensure that the label with the serial number is present. If sending the mobile computer or cradle back to your local supplier or Argox, please use the original package to minimize the chances of damage during shipping.

### 9.2 Read Operation Problems

#### If the mobile computer has a problem reading barcode labels

##### *Barcode reading problems*

- ◆ Make sure the scanning application is loaded and operational.
- ◆ Run “Scanning Setting” program to modify barcode read setting.
- ◆ Barcode may be distorted and should be replaced.
- ◆ Battery needs recharging or replacing

### 9.3 Mobile Computer Problems

##### *Mobile computer does not power on.*

- ◆ Battery needs recharging or replacement.
- ◆ Insure that battery is installed correctly.

##### *Mobile computer shuts itself down*

- ◆ Adjust “Power Properties”
- ◆ Battery needs recharging.

---

---

### *Mobile computer will not shut off*

- ◆ If the mobile computer is processing data, attach a charging cable to insure the battery isn't depleted.

If the mobile computer is connected to AC power, disconnect.

- 3.6.1 Perform a warm boot – **WARNING** – Unsaved data will be lost.
- 3.6.2 Perform a cold boot – **WARNING** – The mobile computer is reset to default settings and data will be lost

---

### *Screen is blank*

- 3.5.5 Make sure mobile computer is powered on.
- 3.6.3 Adjust screen brightness.

---

### *Mobile computer either doesn't respond, or responds inaccurately to touch screen input*

- 3.7.4 Calibrate touch screen.
- 3.6.1 Perform a warm boot – **WARNING** – Unsaved data will be lost.
- 3.6.2 Perform a cold boot – **WARNING** – The mobile computer is reset to default settings and data will be lost

---

### *Battery life is short*

- Adjust "Power Properties" especially if peripherals are used.
- Adjust backlight of LCD or keypad.
- Replace battery pack if old (battery can be recharged approximately 500 cycles.)

---

### *"Low Backup Battery" message*

- Charge mobile computer for 10 hours